





Name _____

A a

avocado tree





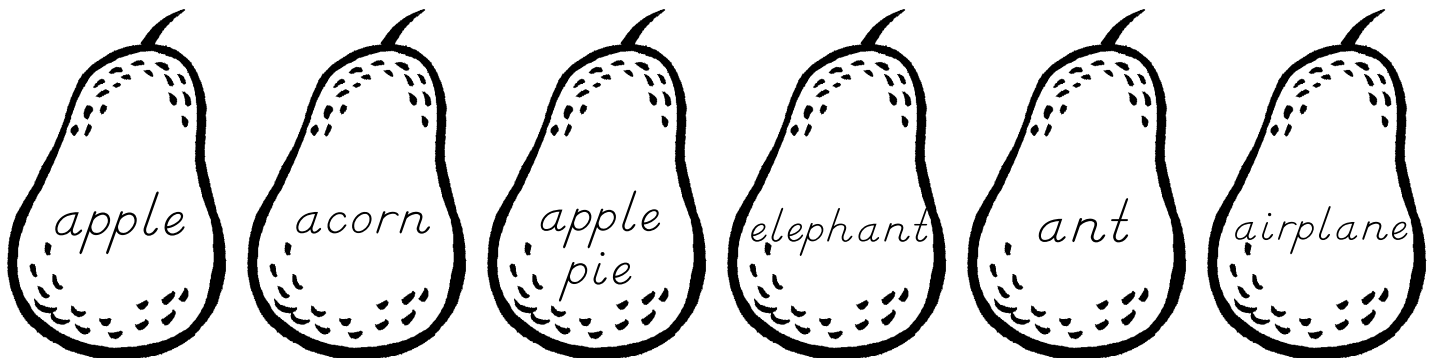

Find an "a" picture for each 
and  and  and  each
picture that begins with the letter a.



Name _____

B b



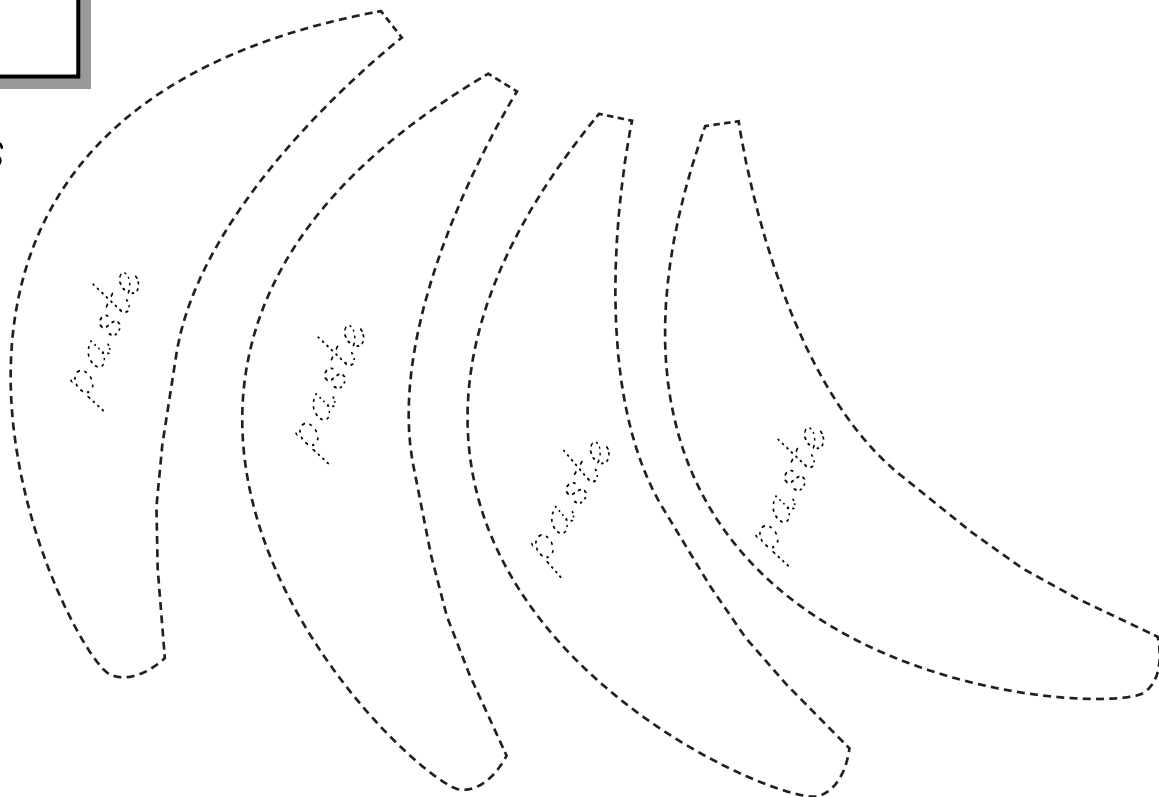

Find a "b" picture for each  and  and 
and  each picture that begins with the letter b.

bananas

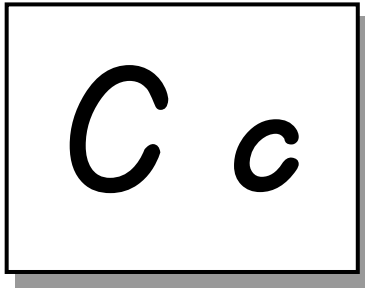

Name _____



Find a "c" picture for each  and  and 
and  each picture that begins with the letter c.

castle

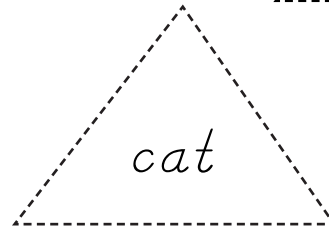
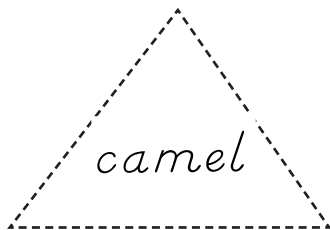
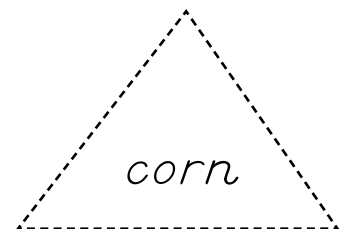
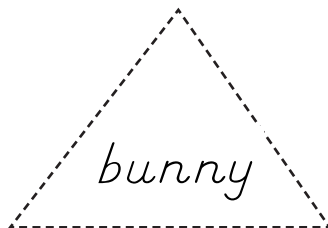
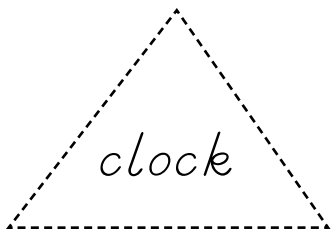
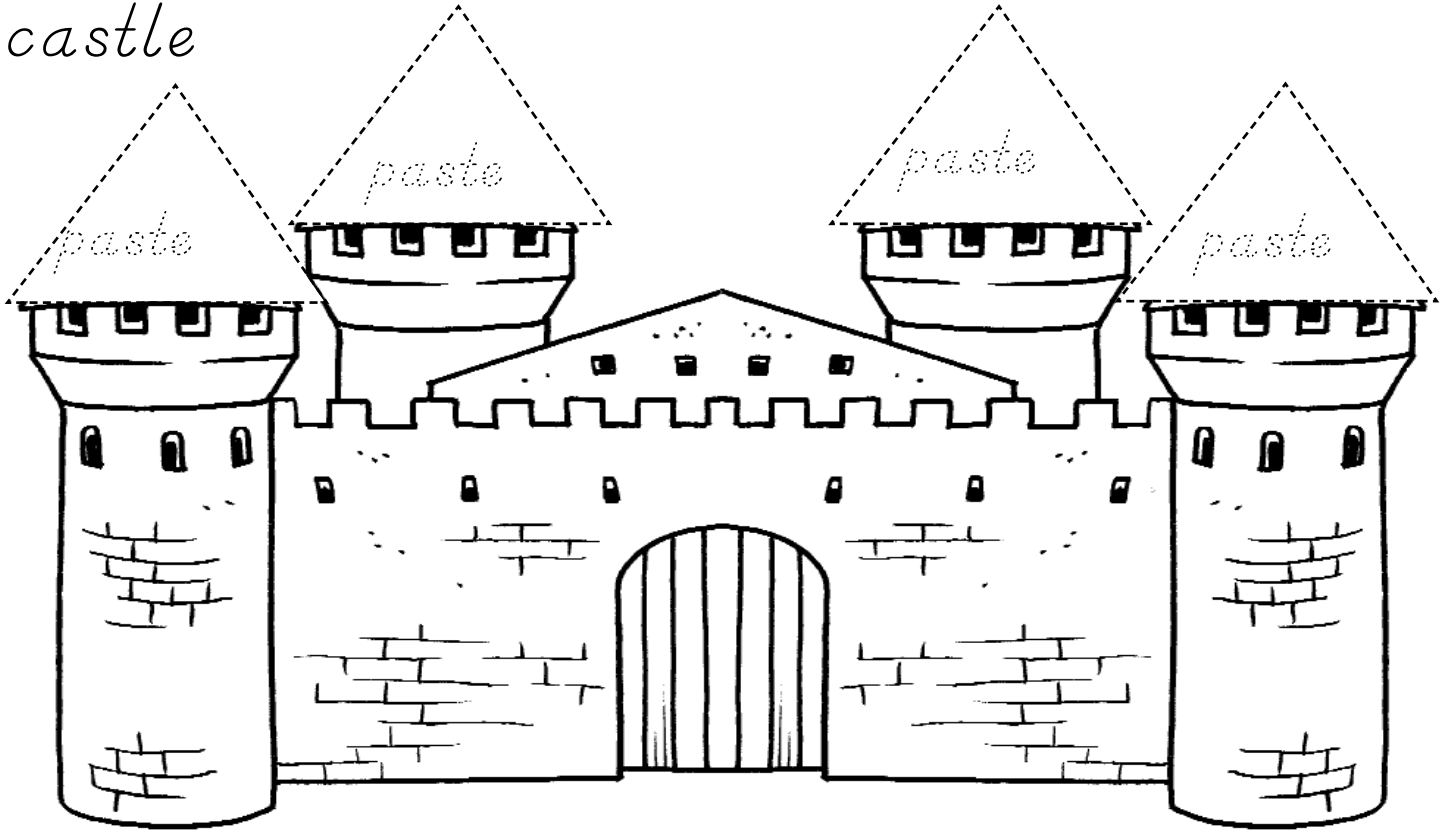

Name _____





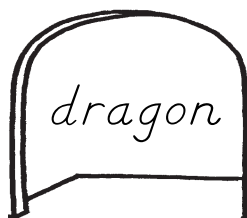
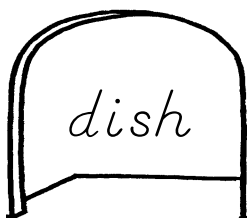
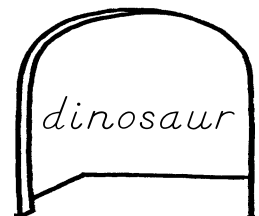
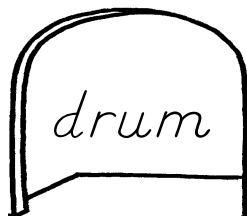
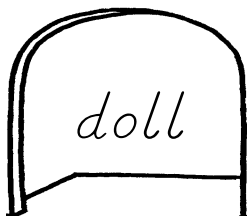
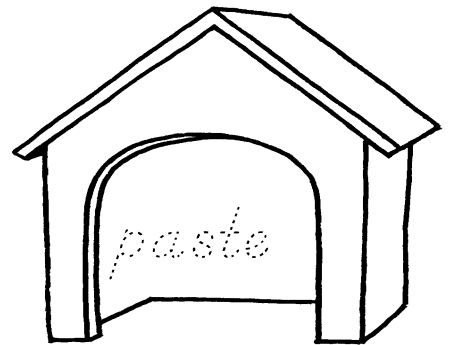
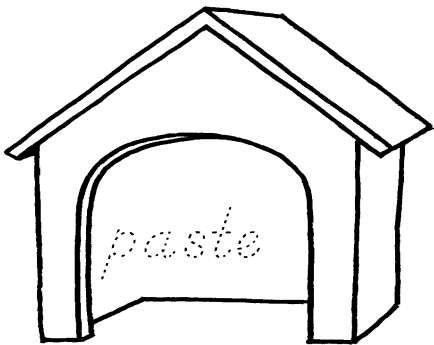
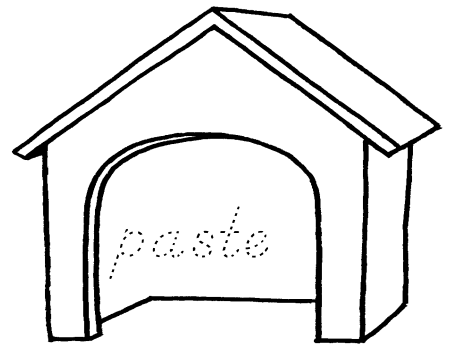
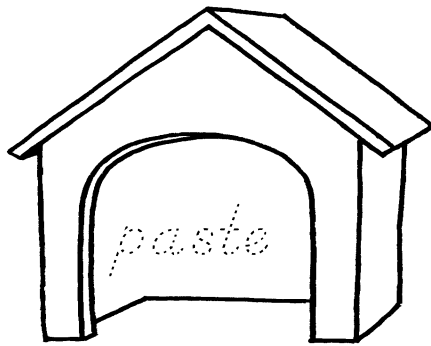
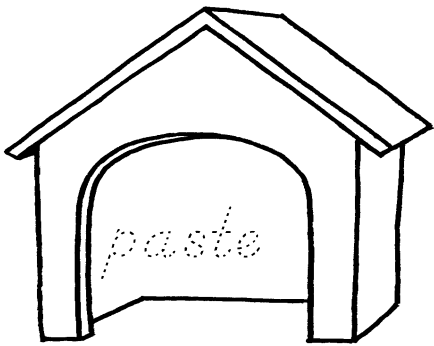

Find a "d" picture for each  and  and  and  each picture that begins with the letter d.

dog houses

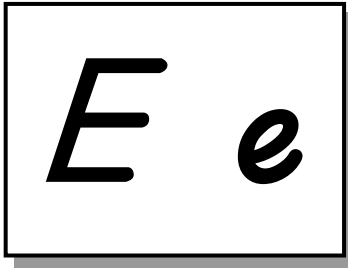

Name _____



Find an "e" picture for each  and  and  and  each picture that begins with the letter e.

eggs

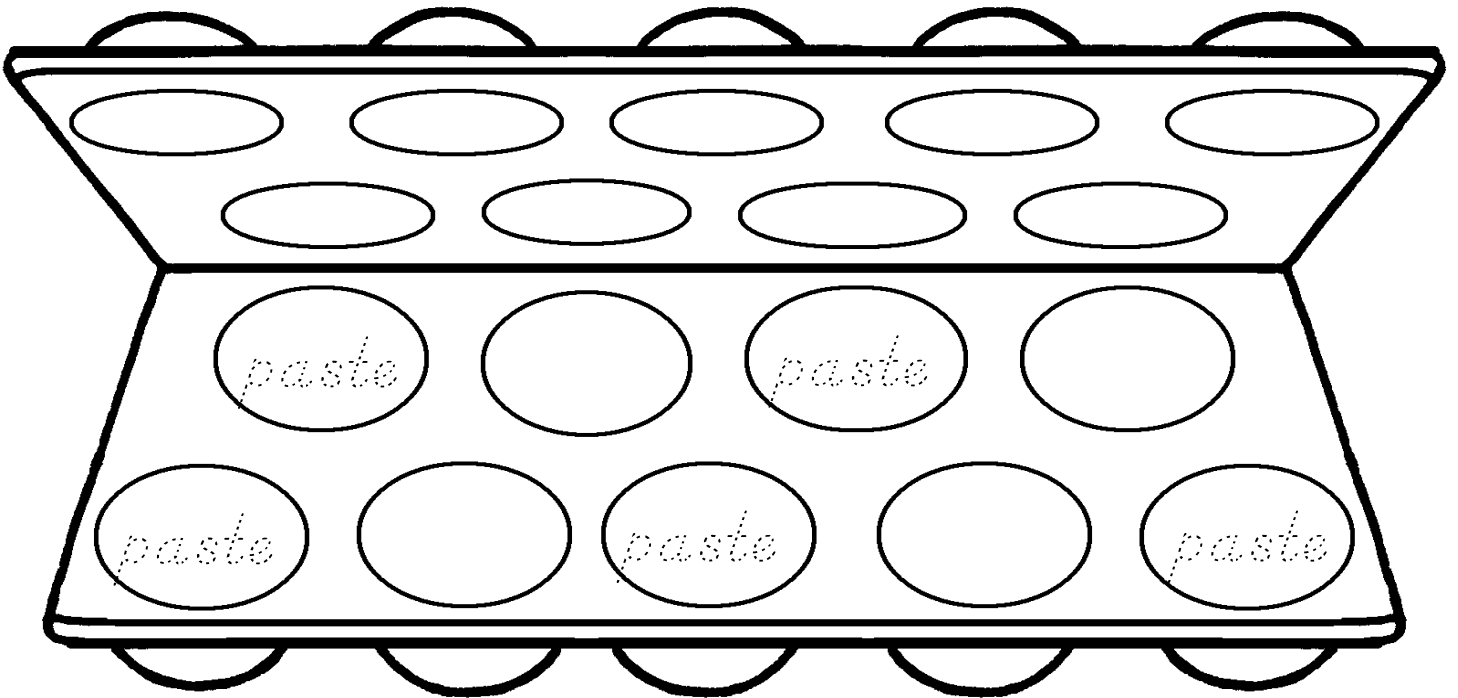

elbow

engine

elf





eggplant

ear

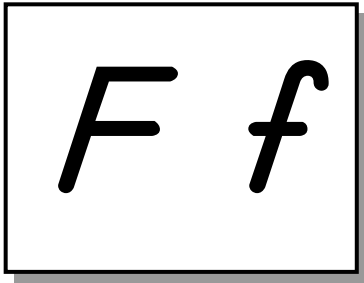
ice cream

Name _____



Find an "f" picture for each  and  and 
and  each picture that begins with the letter f.

flowers

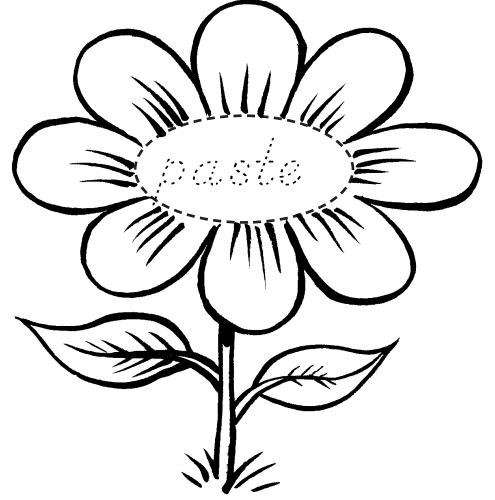
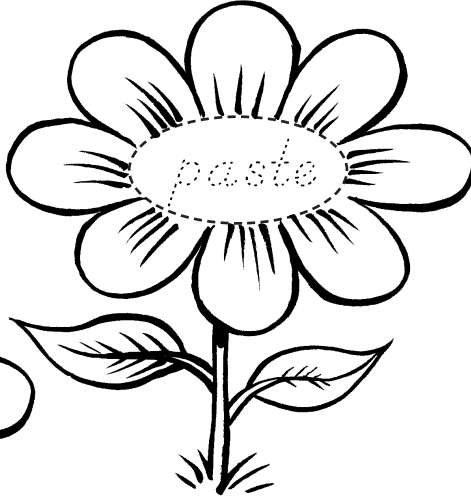
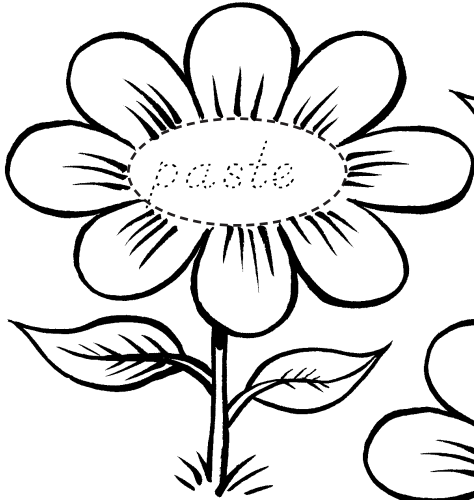

glasses

fish

fly





frog

flag

foot

Name _____

G g



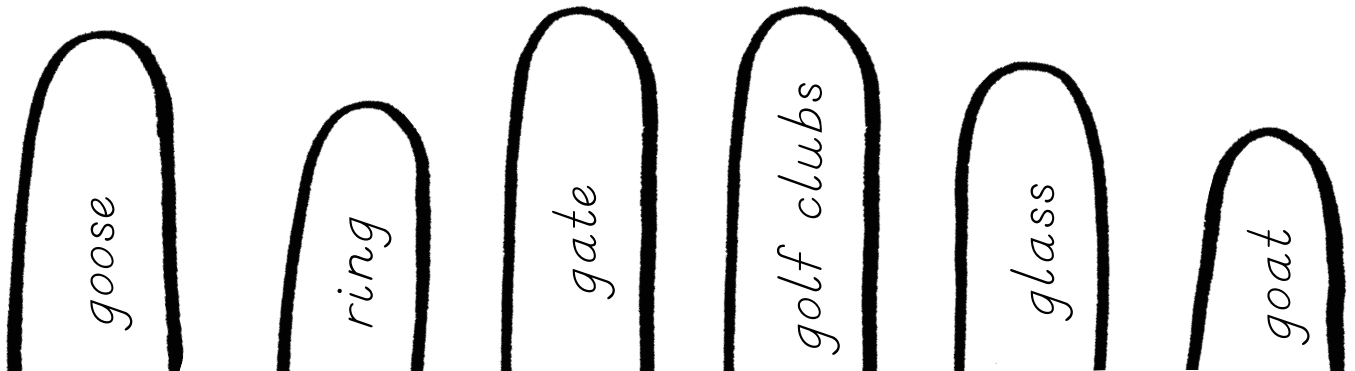
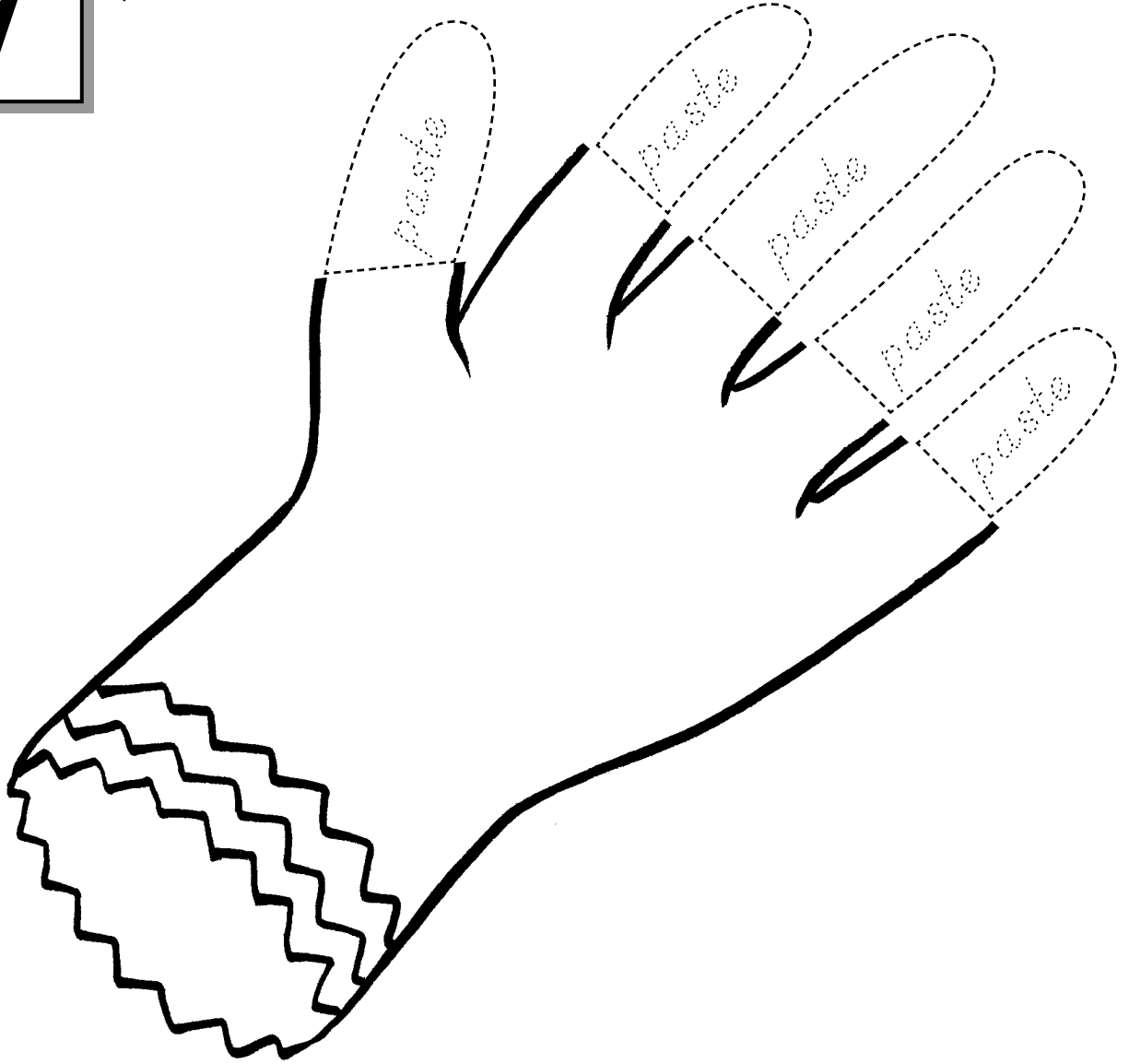

Find a "g" picture for each  and  and  and  each picture that begins with the letter g.

glove



Name _____

H h

Find an "h" picture for each  and  and 
and  each picture that begins with the letter h.

hearts

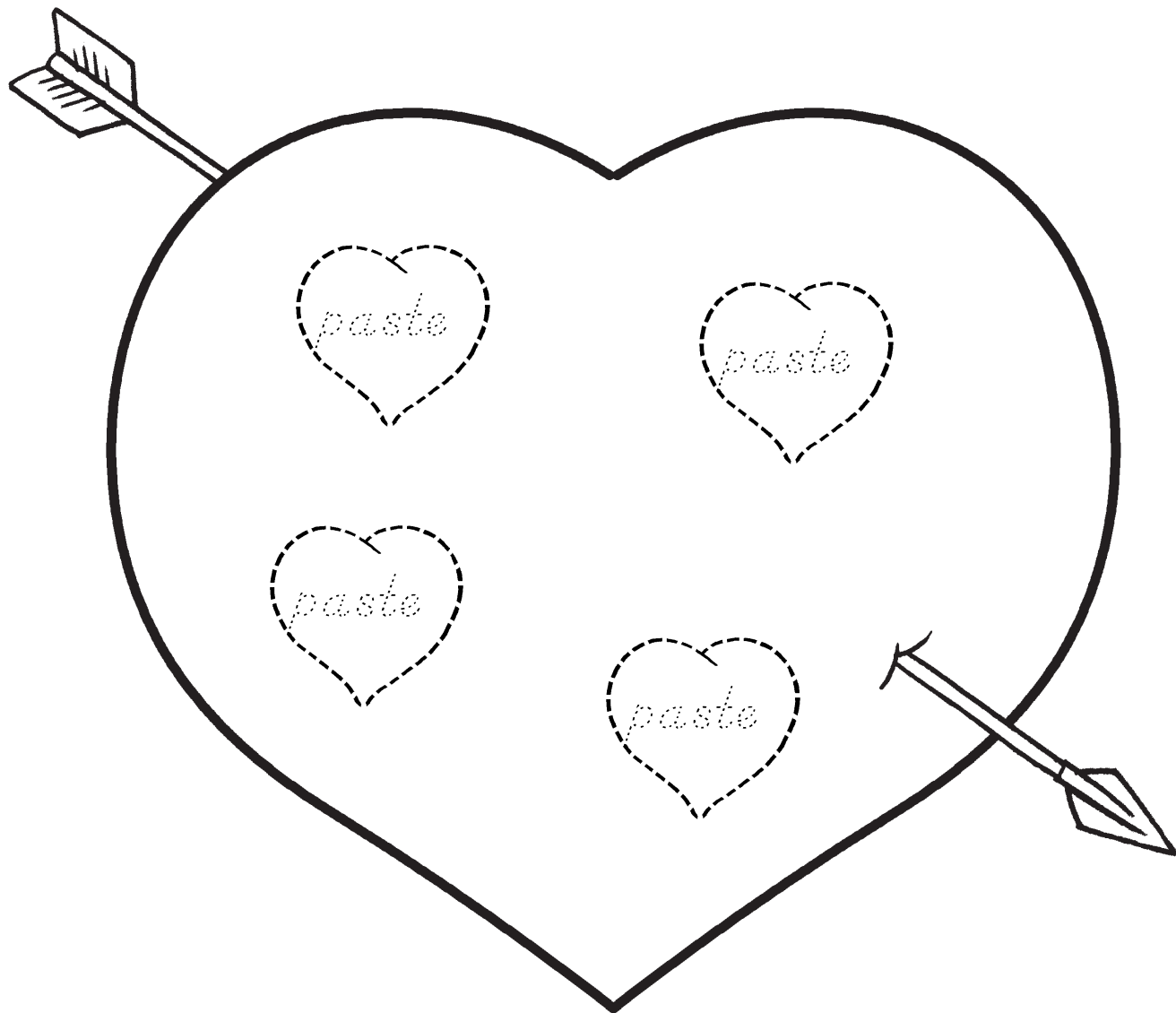

rainbow

horse





hat

honey

hanger

Name _____

I i

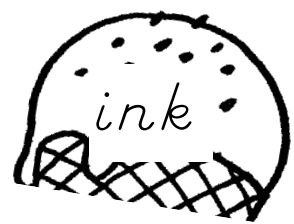
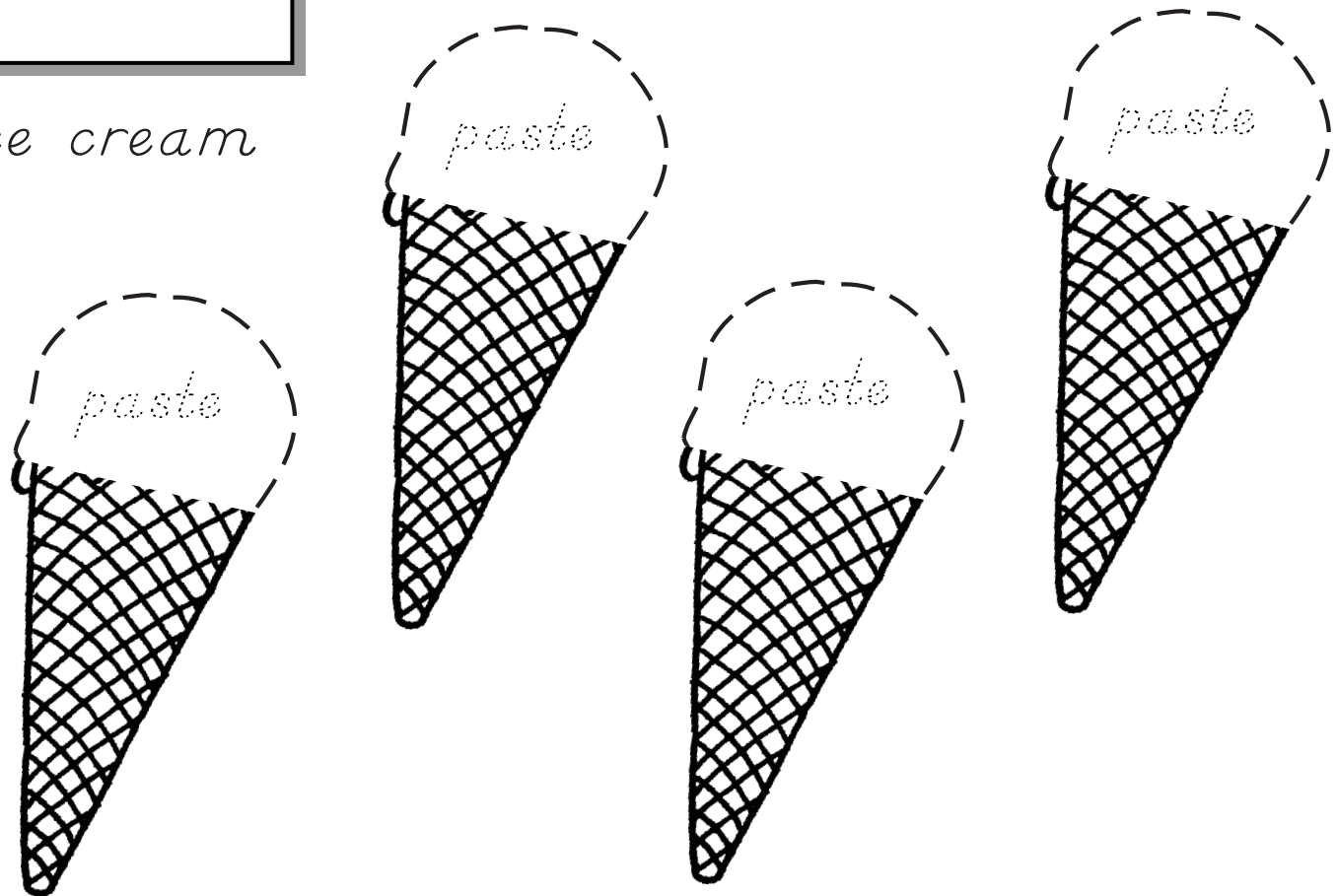

Find an "i" picture for each  and  and 
and  each picture that begins with the letter i.

ice cream

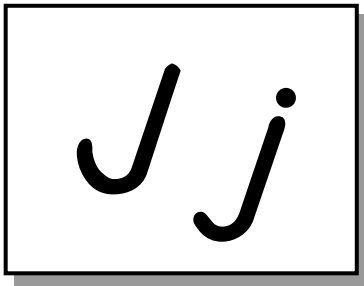

Name _____





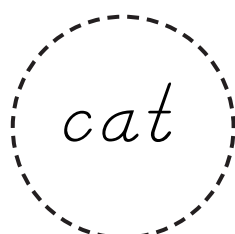
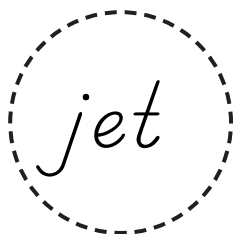
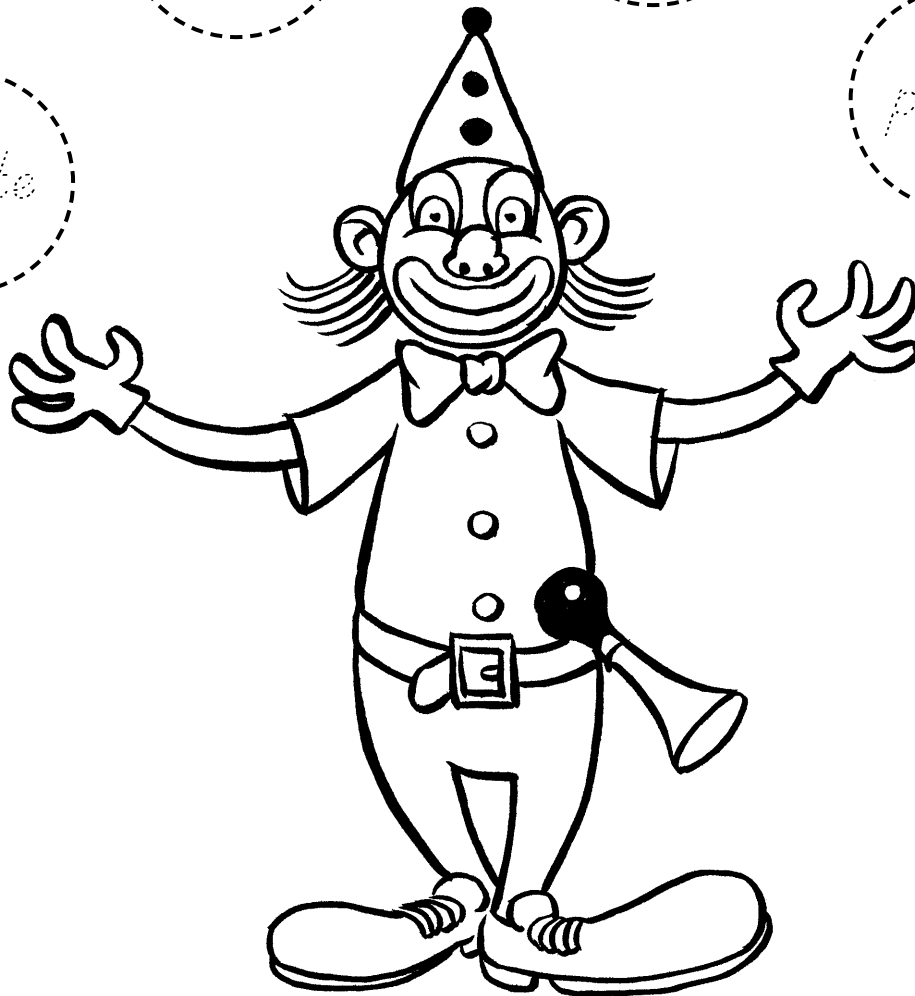

Find a "j" picture for each ○ and  and  and  each picture that begins with the letter j.

juggle



Name _____

K k



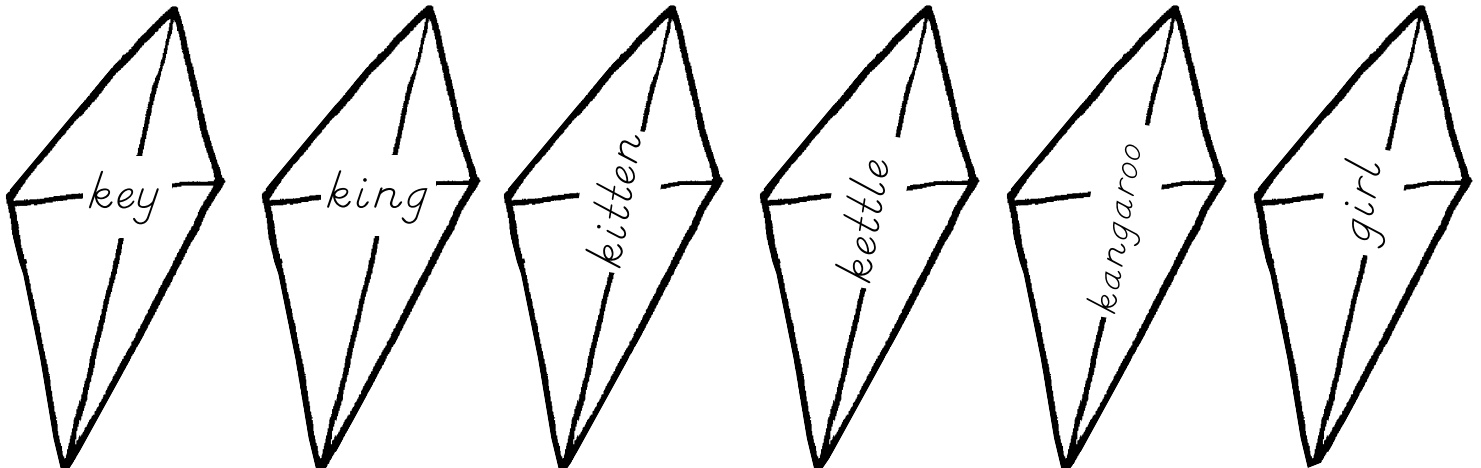
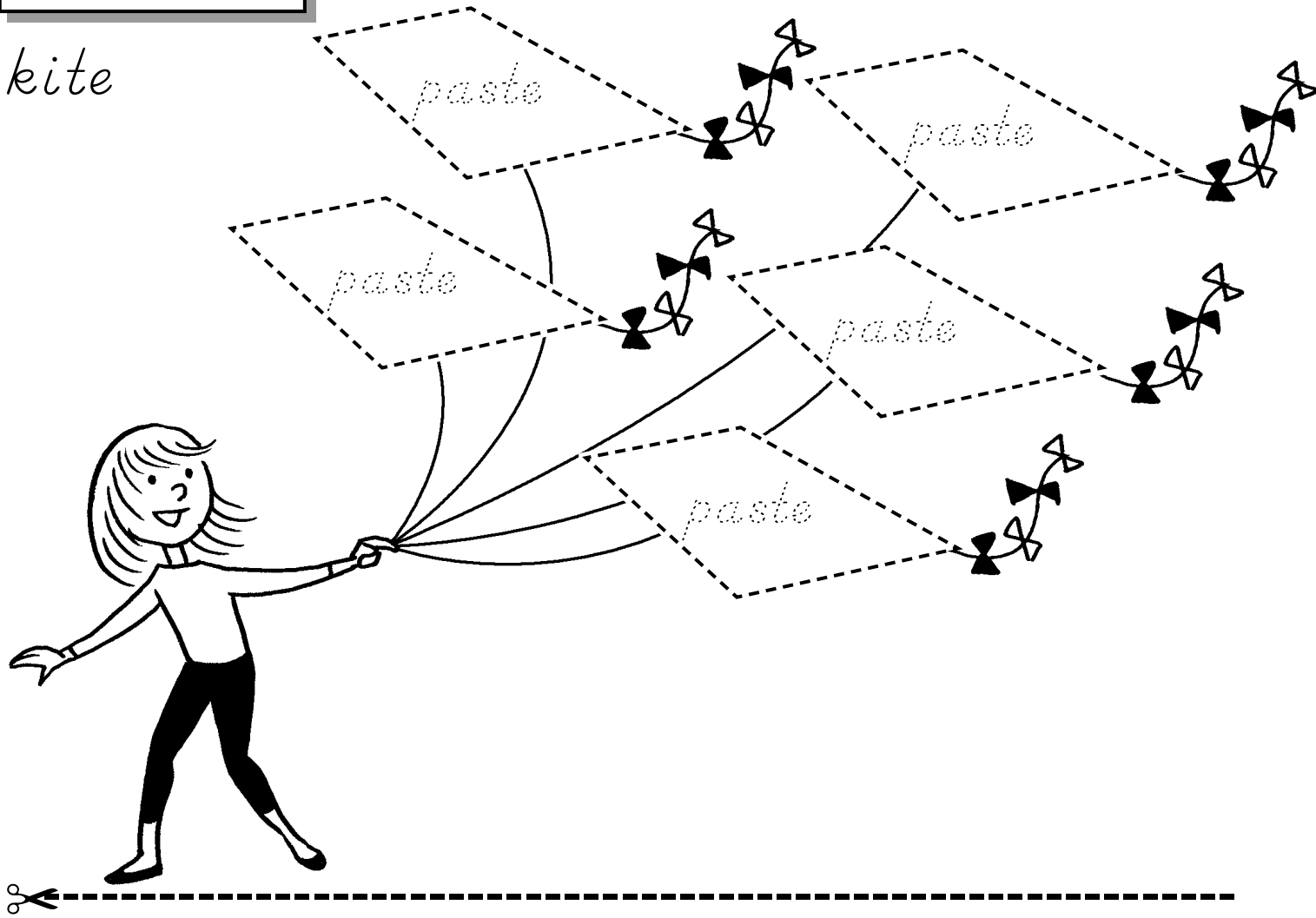

Find a "k" picture for each  and  and 
and  each picture that begins with the letter k.

kite

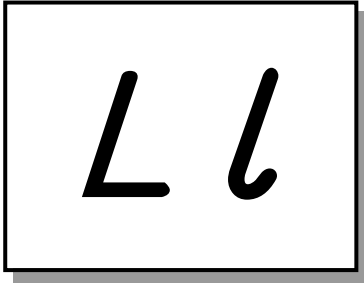

Name _____





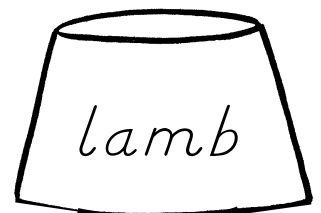
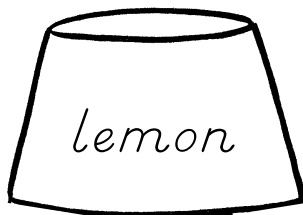
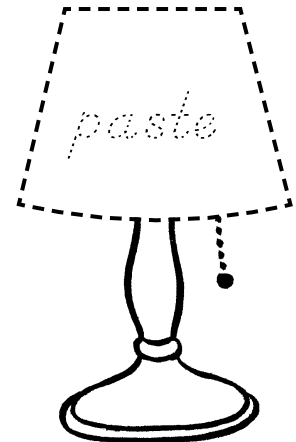
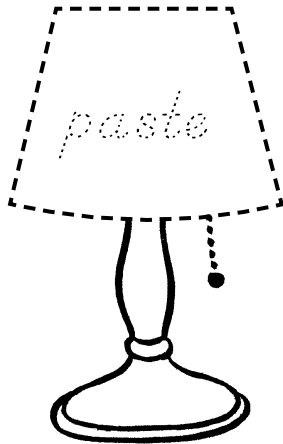
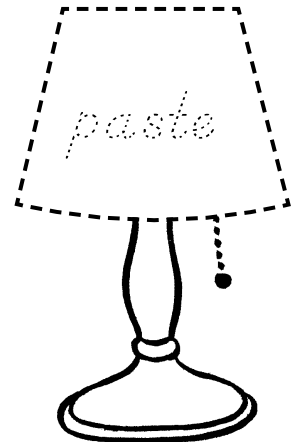
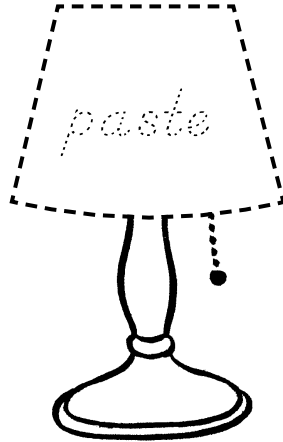
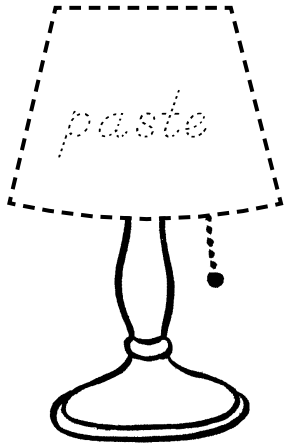

Find an "l" picture for each  and  and  and  each picture that begins with the letter l.

lamps



Name _____



Find an "m" picture for each  and  and  and  each picture that begins with the letter *m*.

music

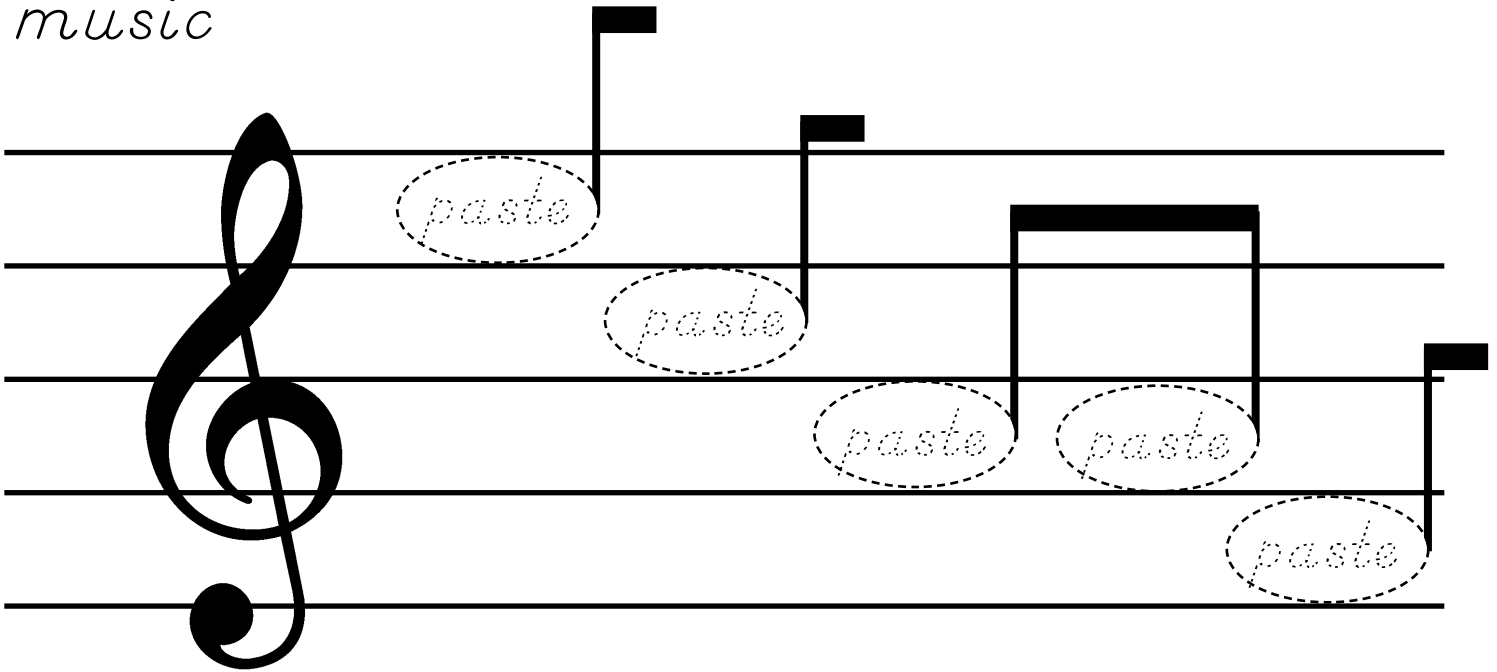

mouse

moon

monkey





kite

mushroom

mailbox

Name _____

N n



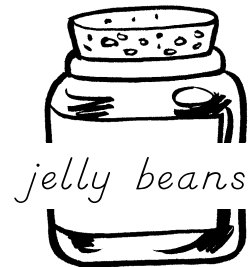
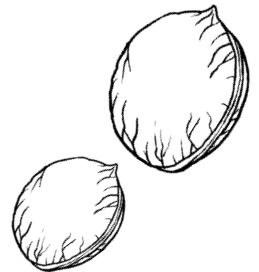
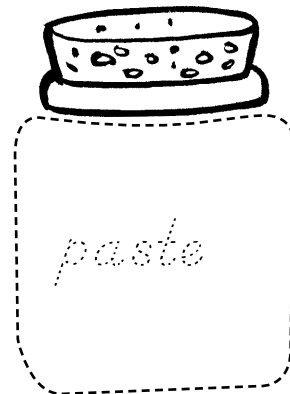
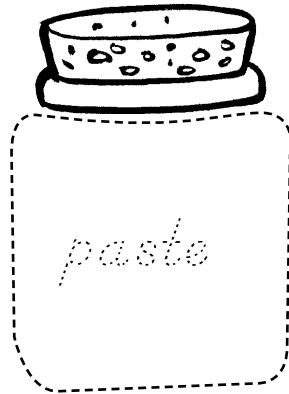
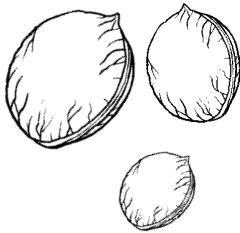
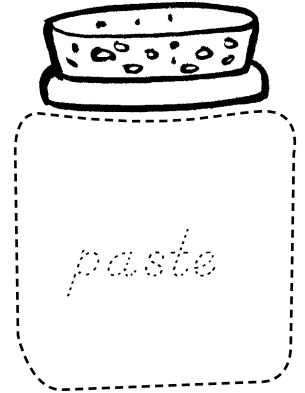
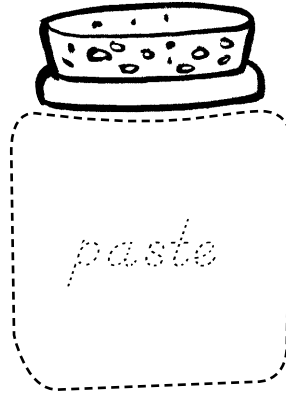

Find an "n" picture for each  and  and  and  each picture that begins with the letter n.

nuts

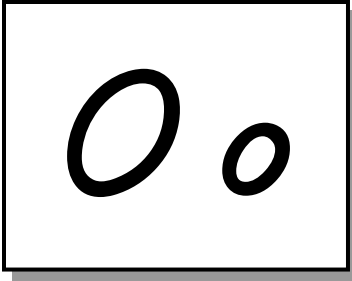

Name _____





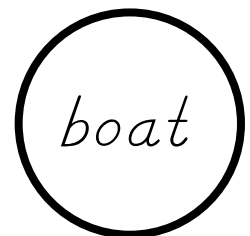
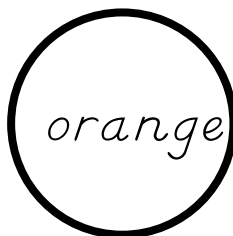
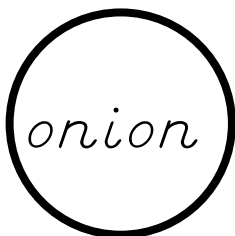
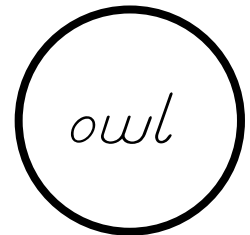
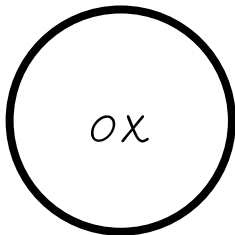
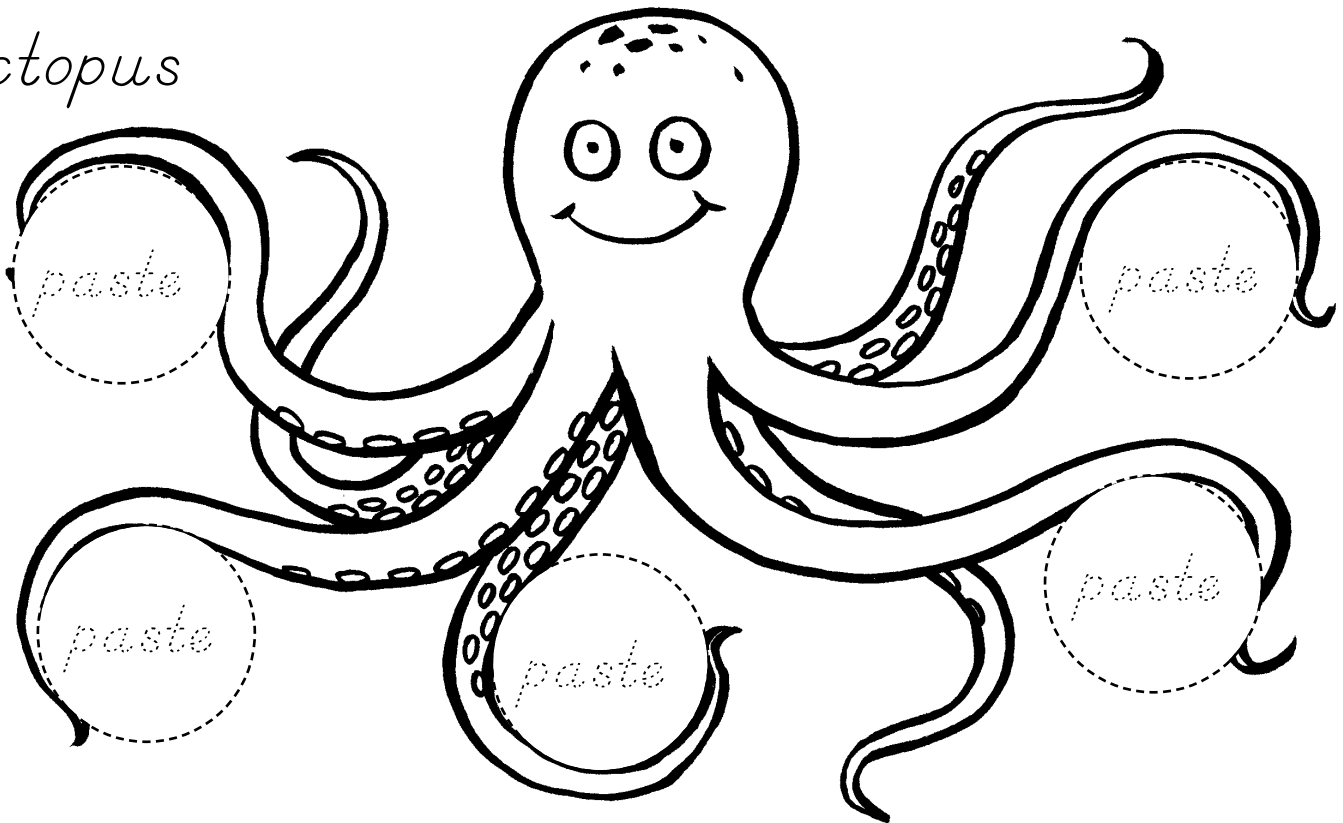

Find an "o" picture for each  and  and  and  each picture that begins with the letter o.

octopus

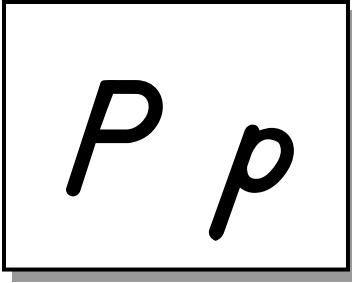

Name _____



Find a "p" picture for each  and  and  and  each picture that begins with the letter p.

piano

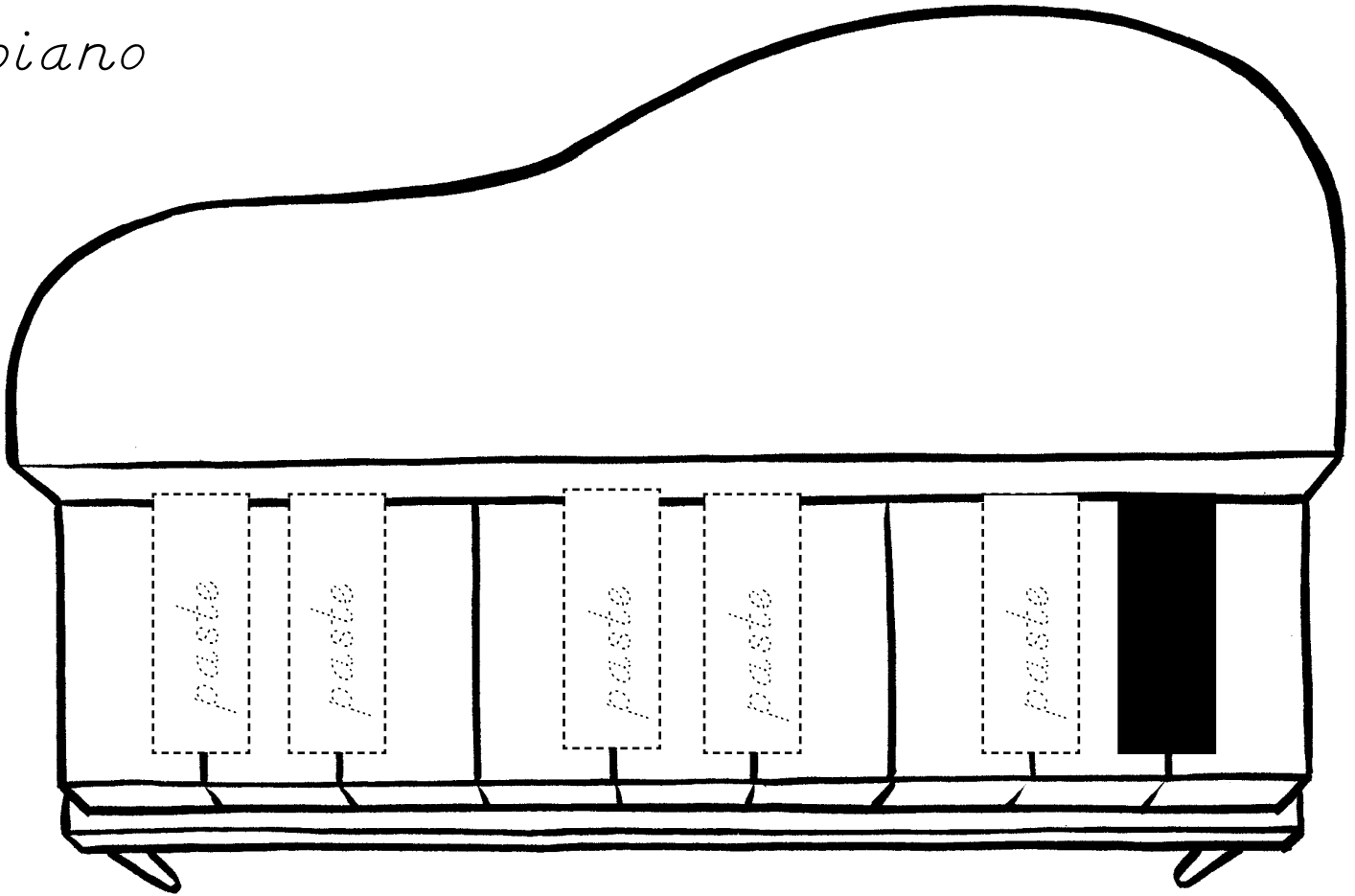

pot

pineapple

umbrella





pizza

pickle

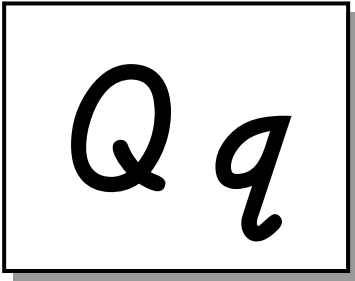
puppy

Name _____



Find a "q" picture for each  and  and  and  each picture that begins with the letter q.

quilt

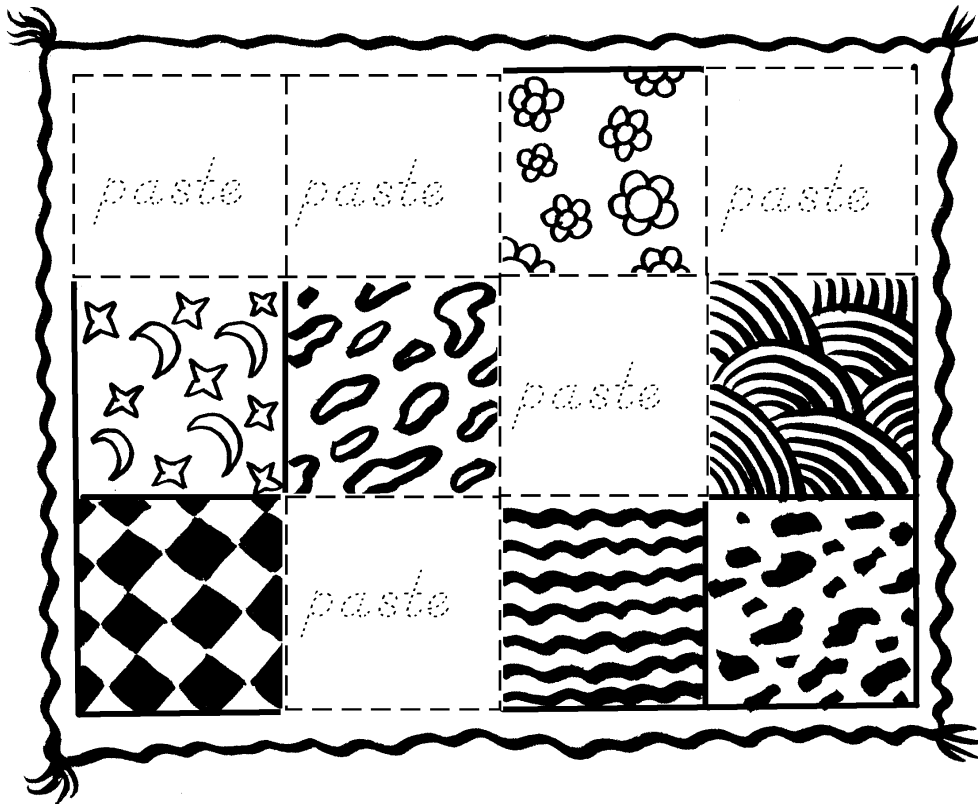

quail

quarter

queen





cookies

quart
of milk

question
mark

Name _____

R r

Find an "r" picture for each  and  and  and  each picture that begins with the letter r.

rabbits

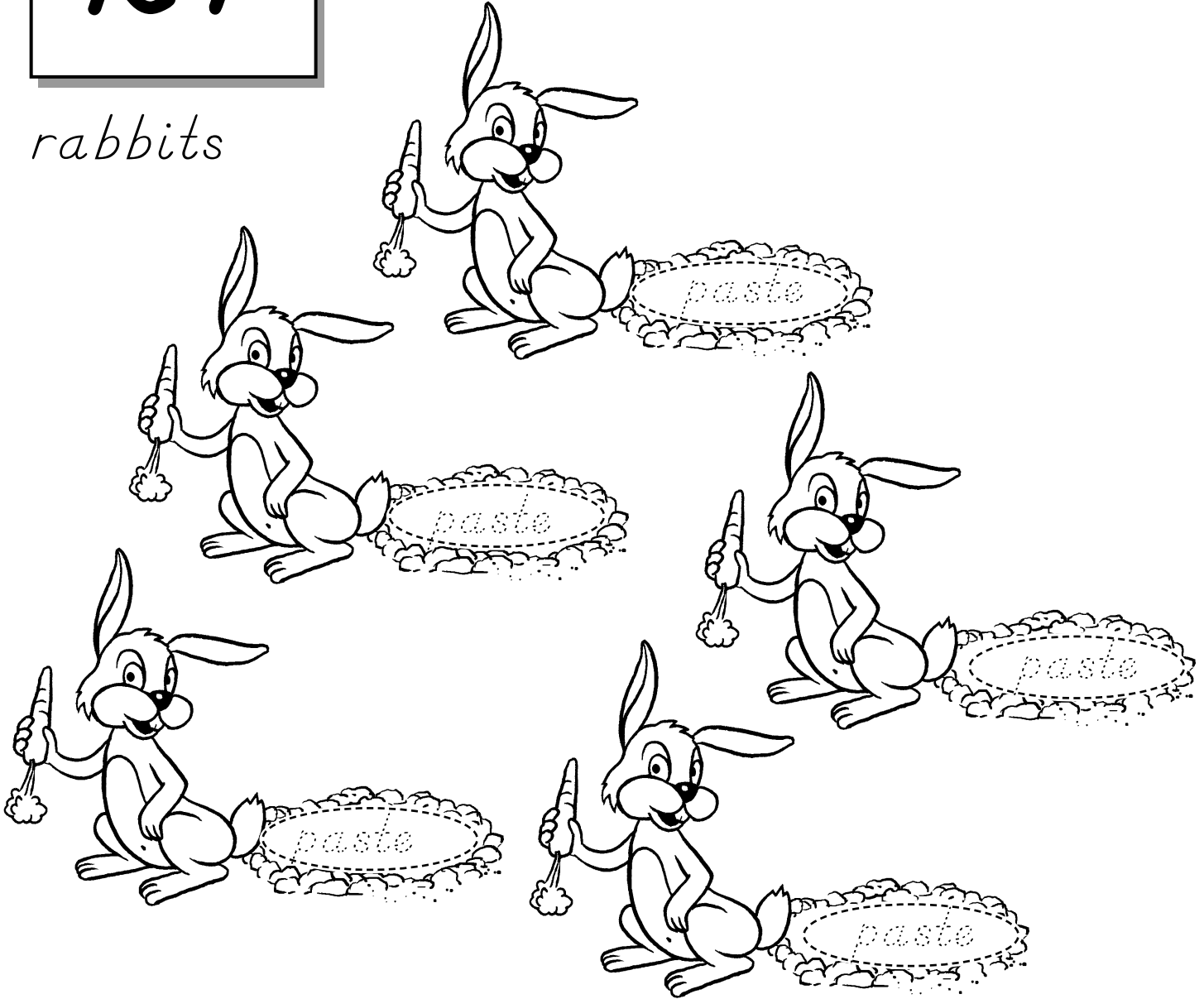

cloud

rain

rake





rose

roller skates

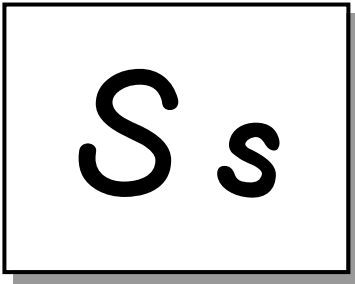
rocket

Name _____



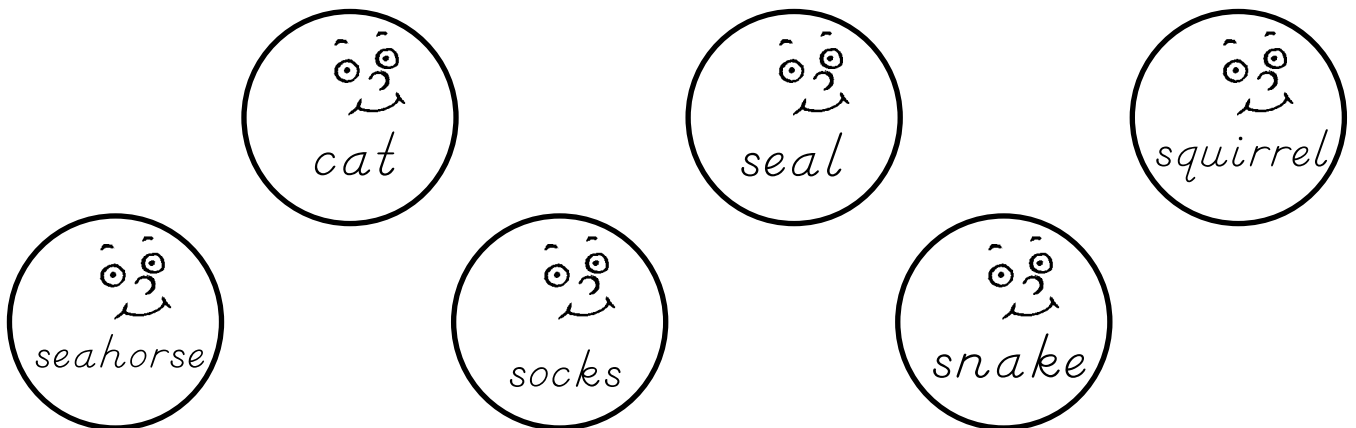
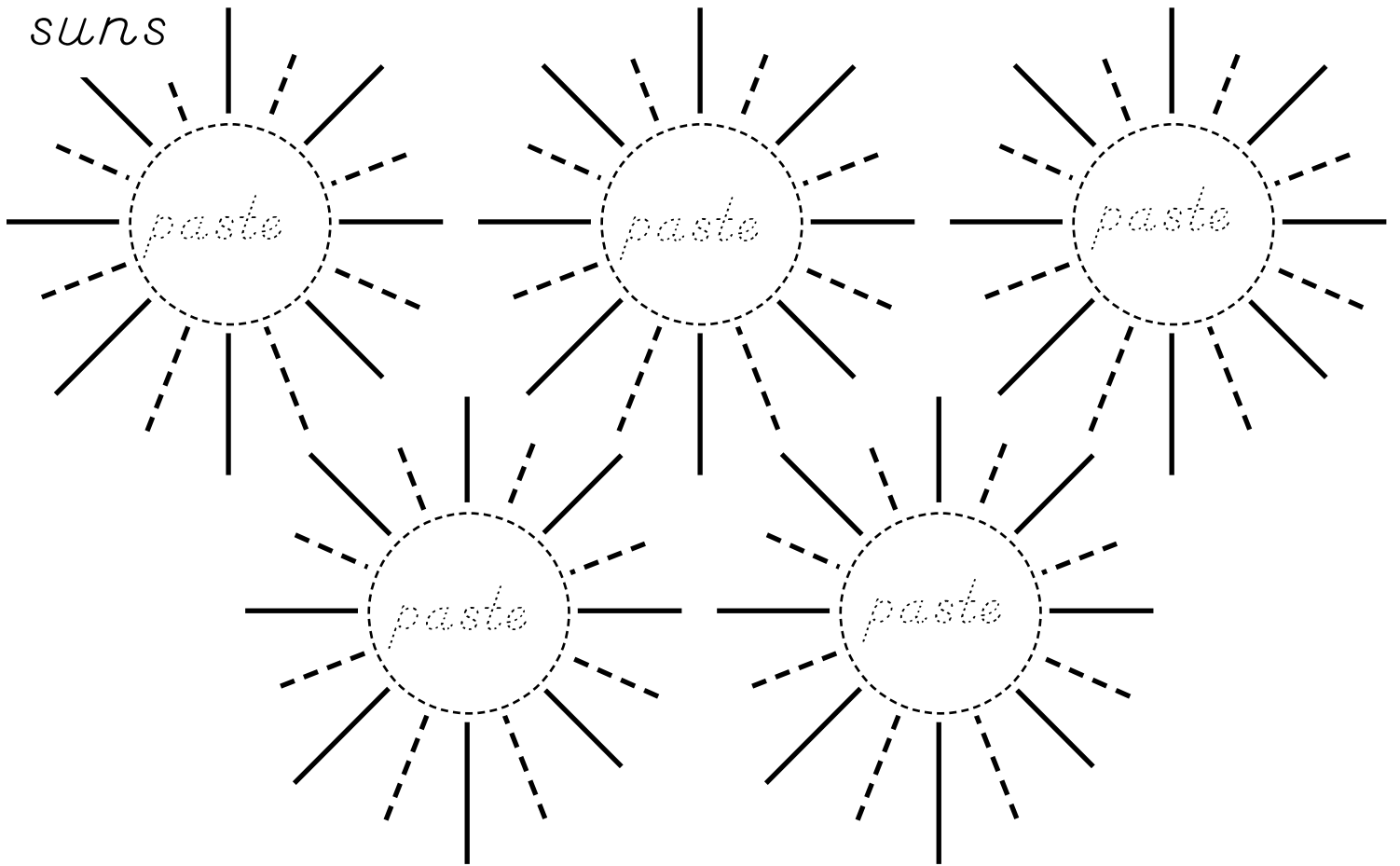

Find an "s" picture for each  and  and  and  each picture that begins with the letter s.

suns



Name _____

T t

Find a "t" picture for each and  and  and  each picture that begins with the letter t.

televisions

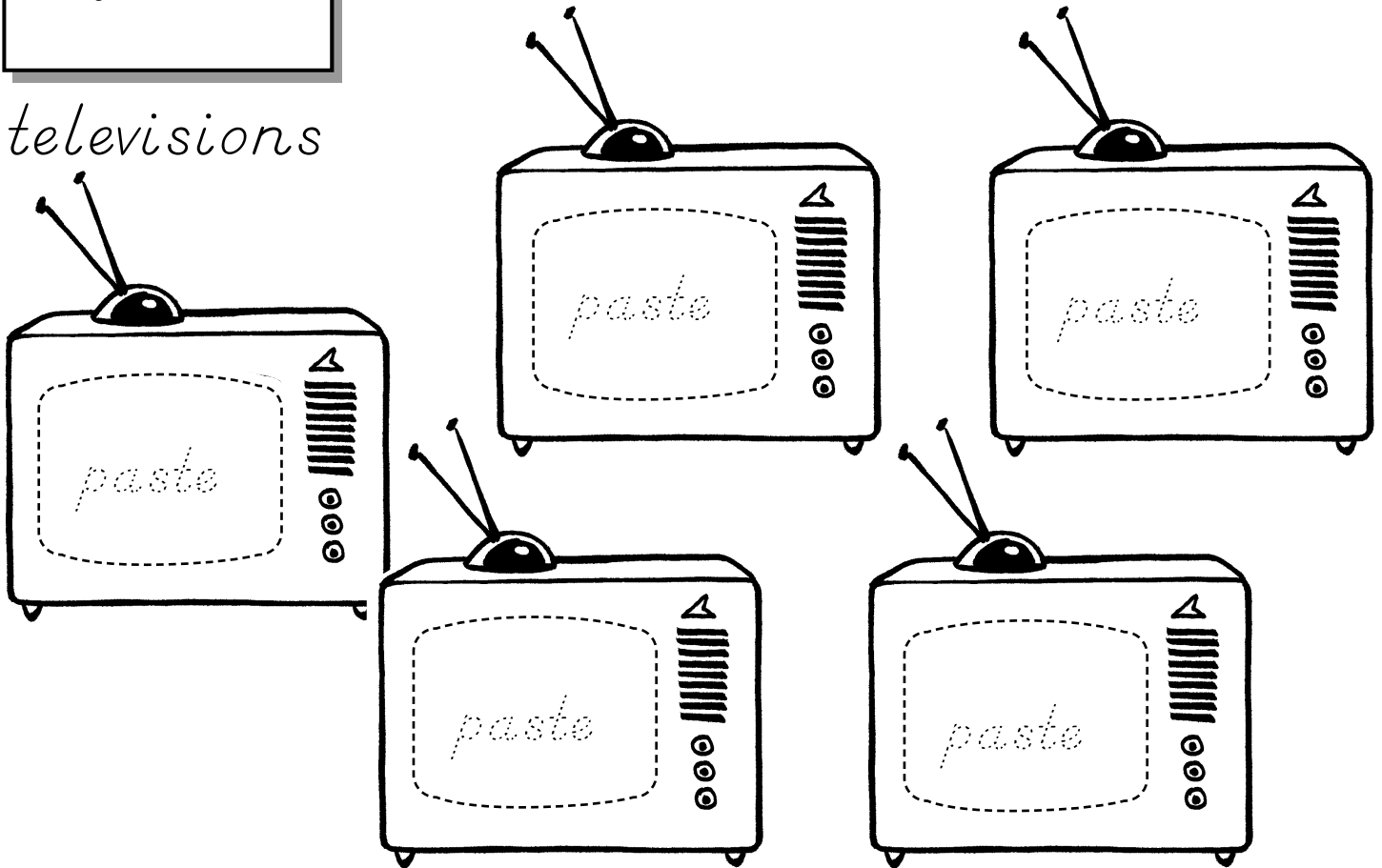

telephone

turtle

toothbrush





tiger

violin

television

Name _____

U u



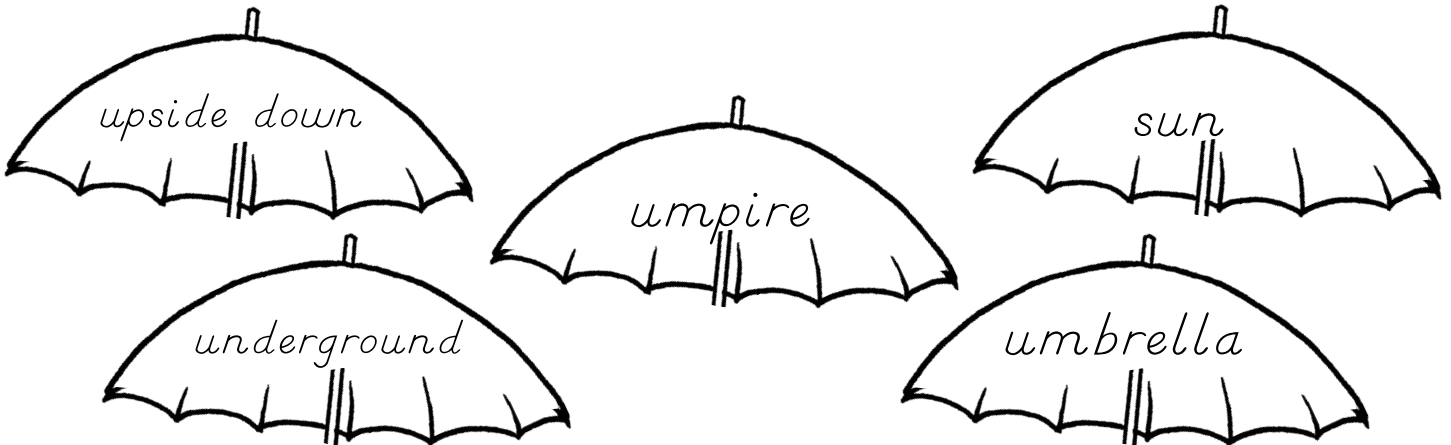
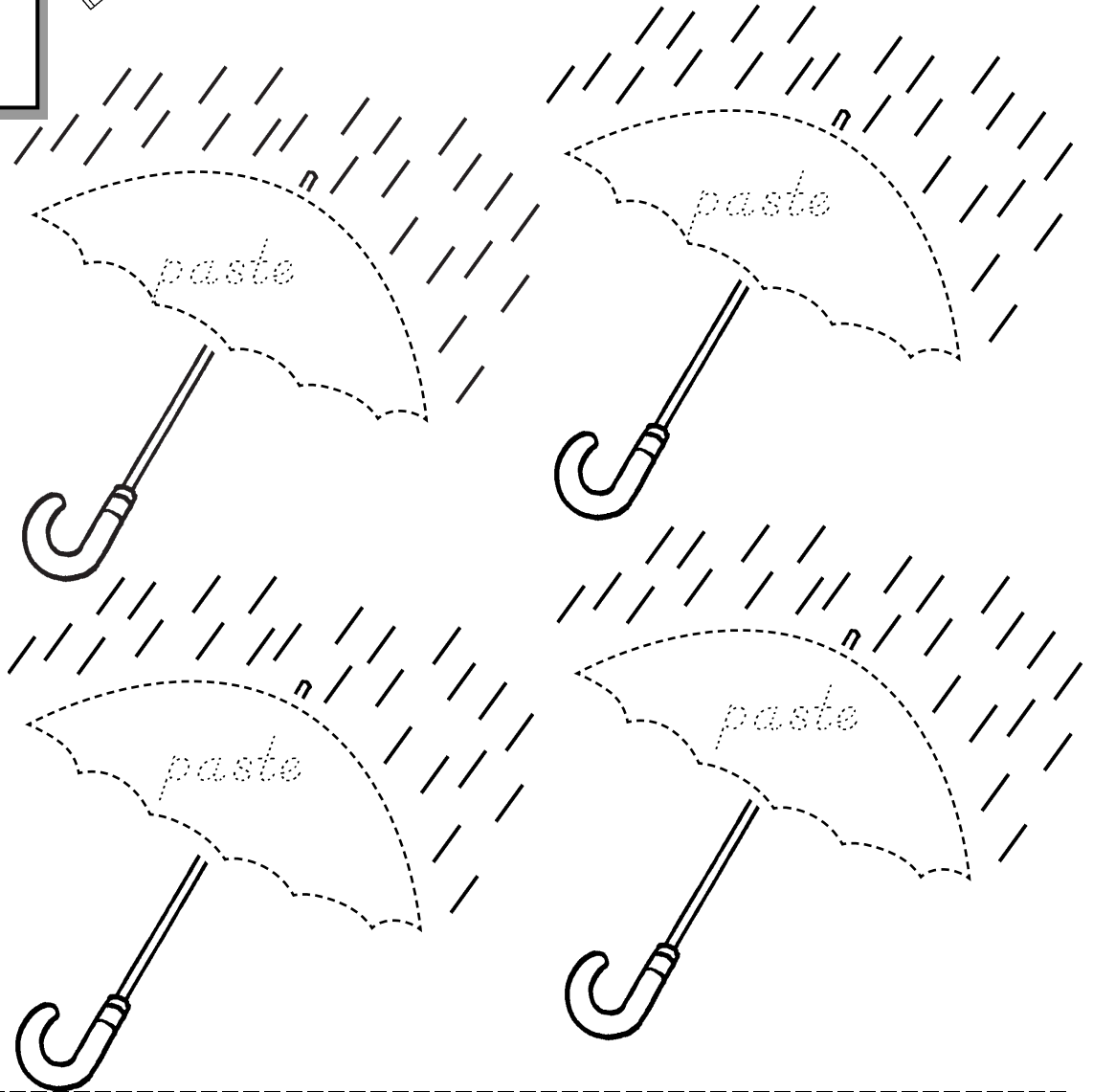

Find a "u" picture for each  and  and  and  each picture that begins with the letter u.

umbrellas



Name _____





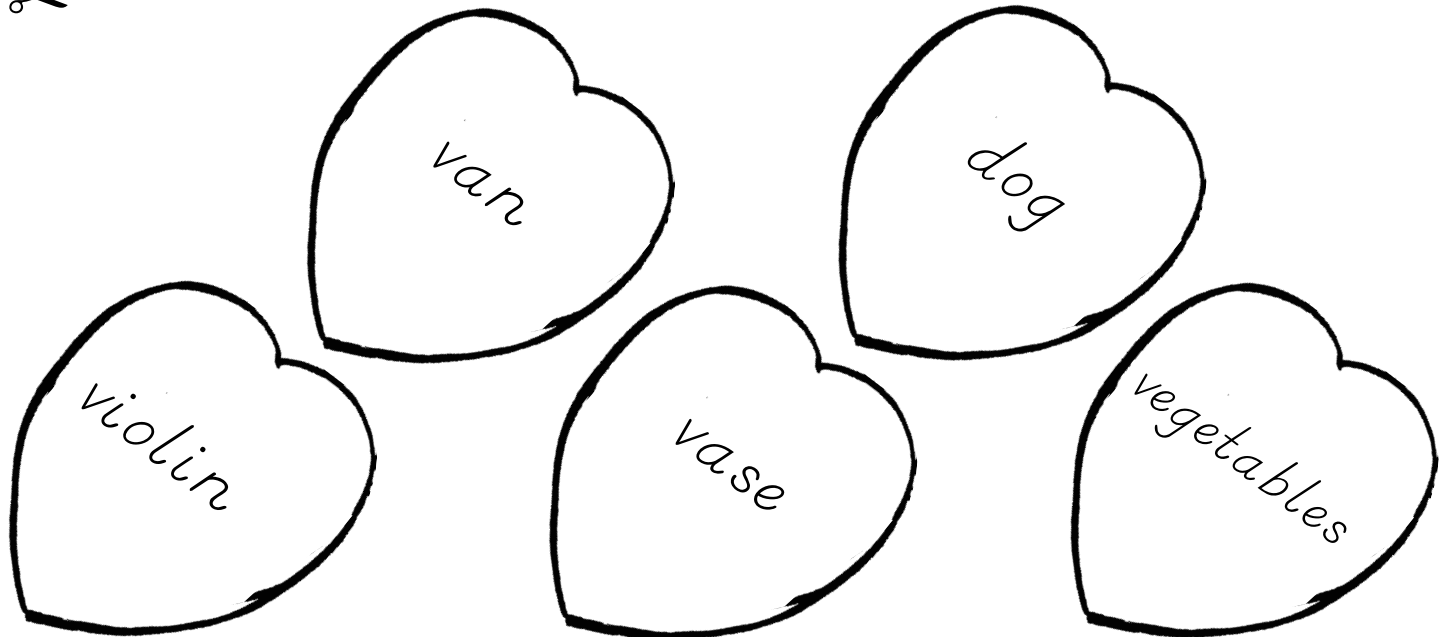
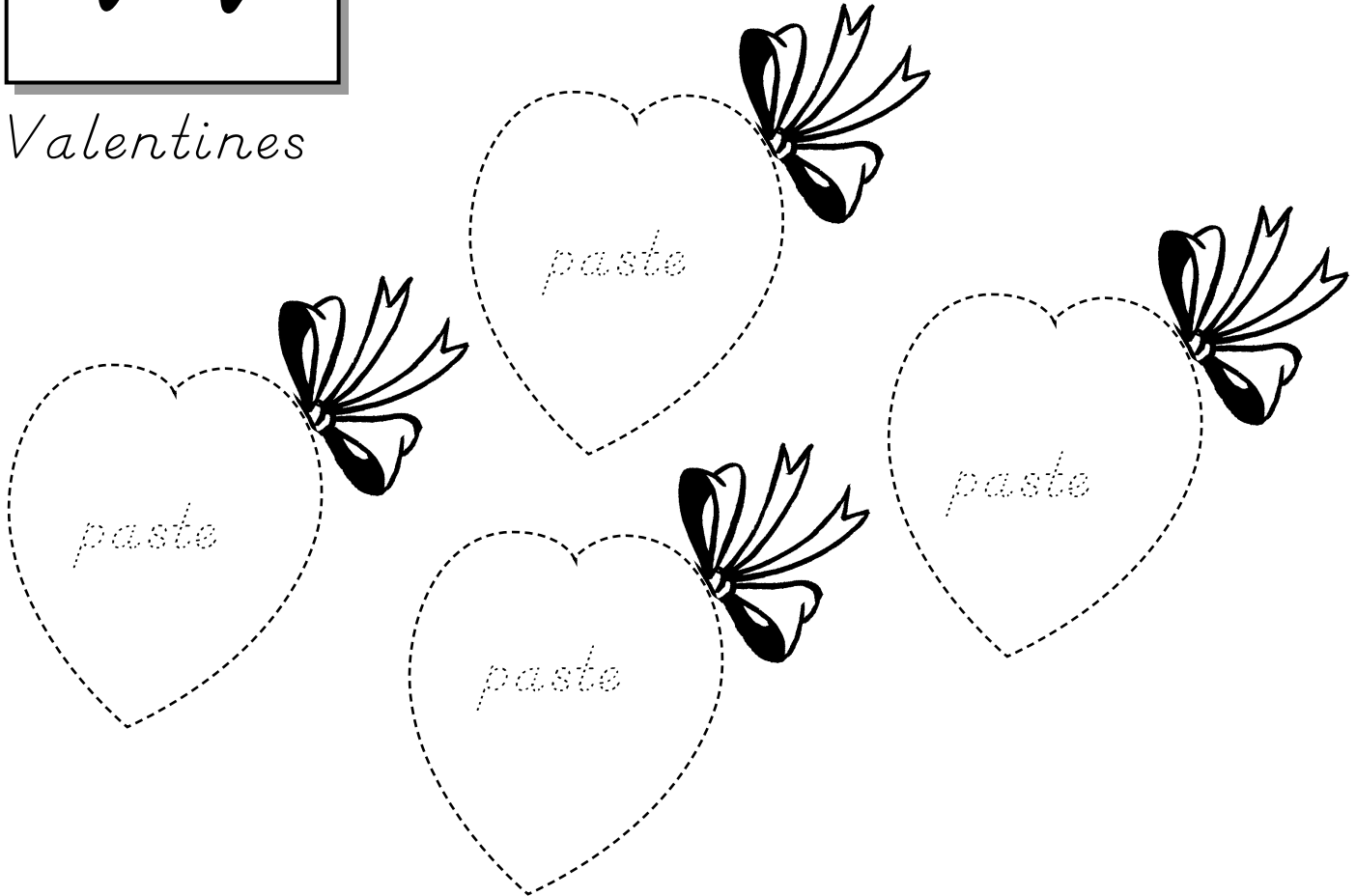

Find a "v" picture for each  and  and  and  each picture that begins with the letter v.

Valentines



Name _____





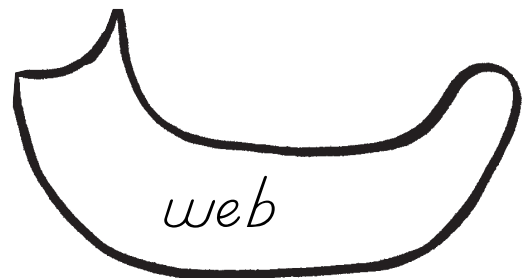
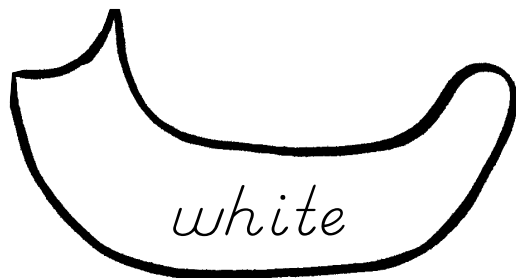
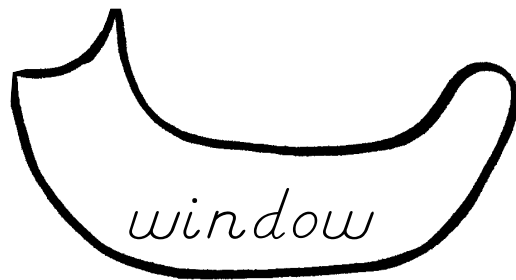
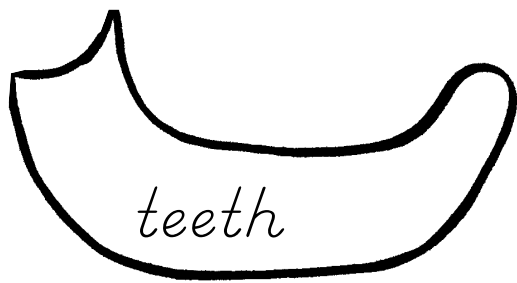
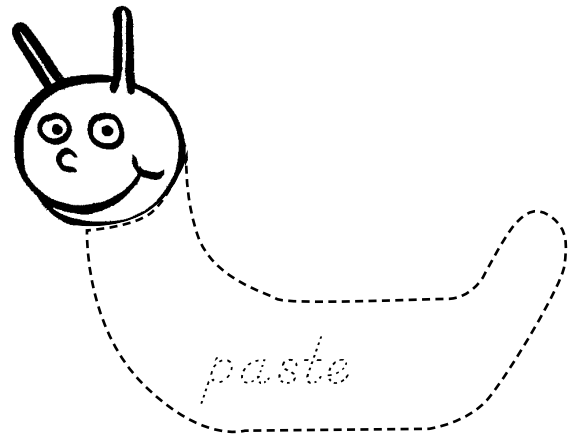
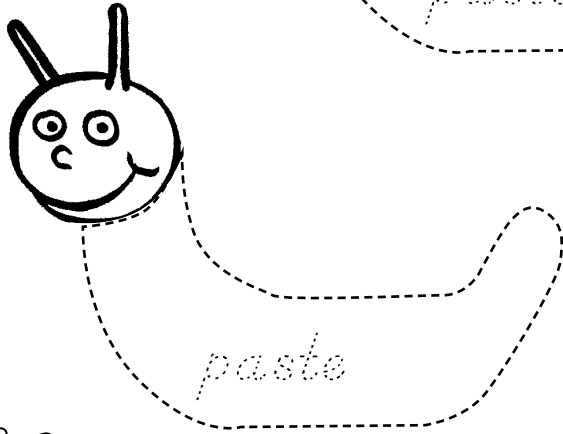
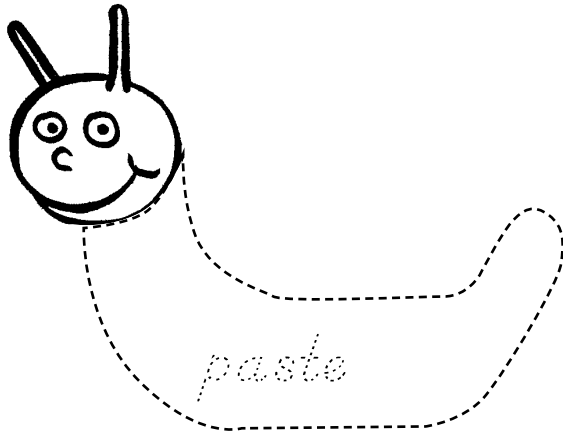

Find a "w" picture for each  and  and  and  each picture that begins with the letter w.

worms

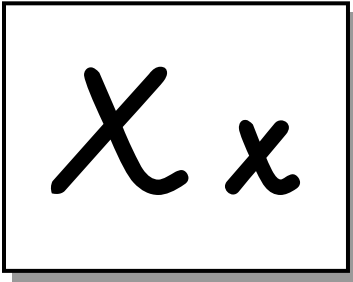

Name _____





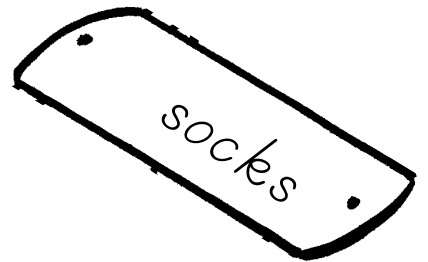
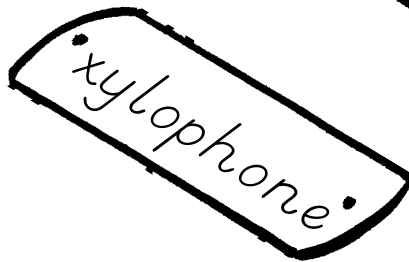
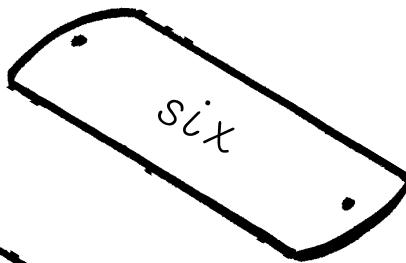
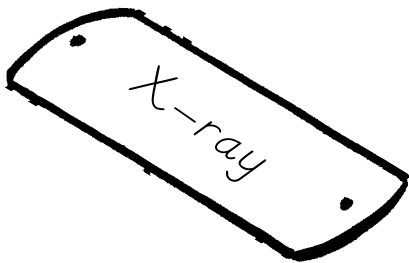
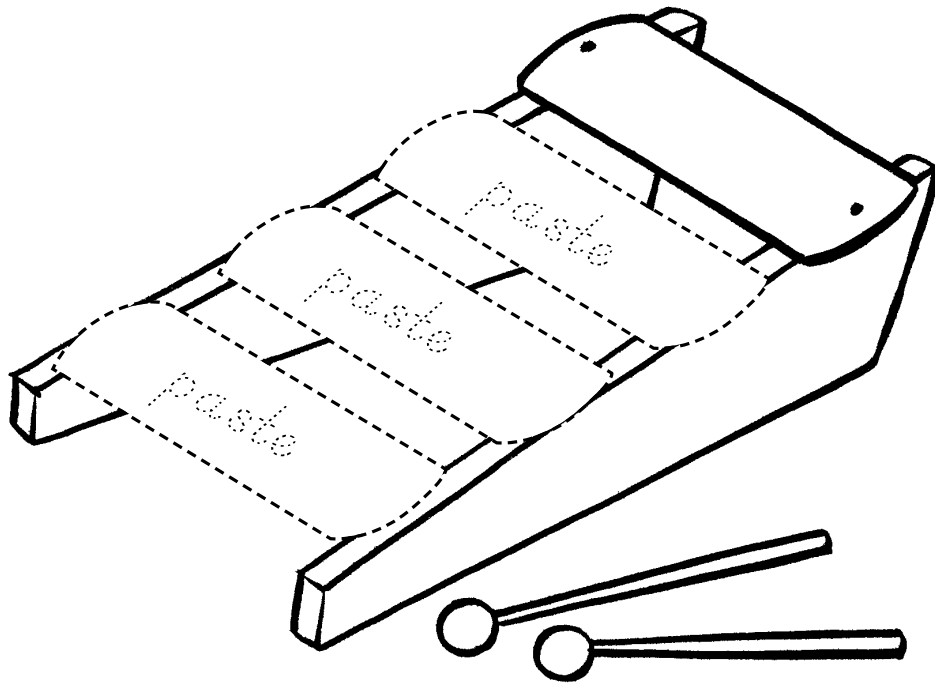

Find an "x" picture for each  and  and  and  each picture that has the letter x.

xylophone

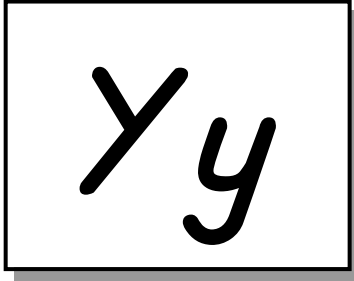

Name _____



Find a "y" picture for each  and  and  and  each picture that has the letter y.

yo-yo

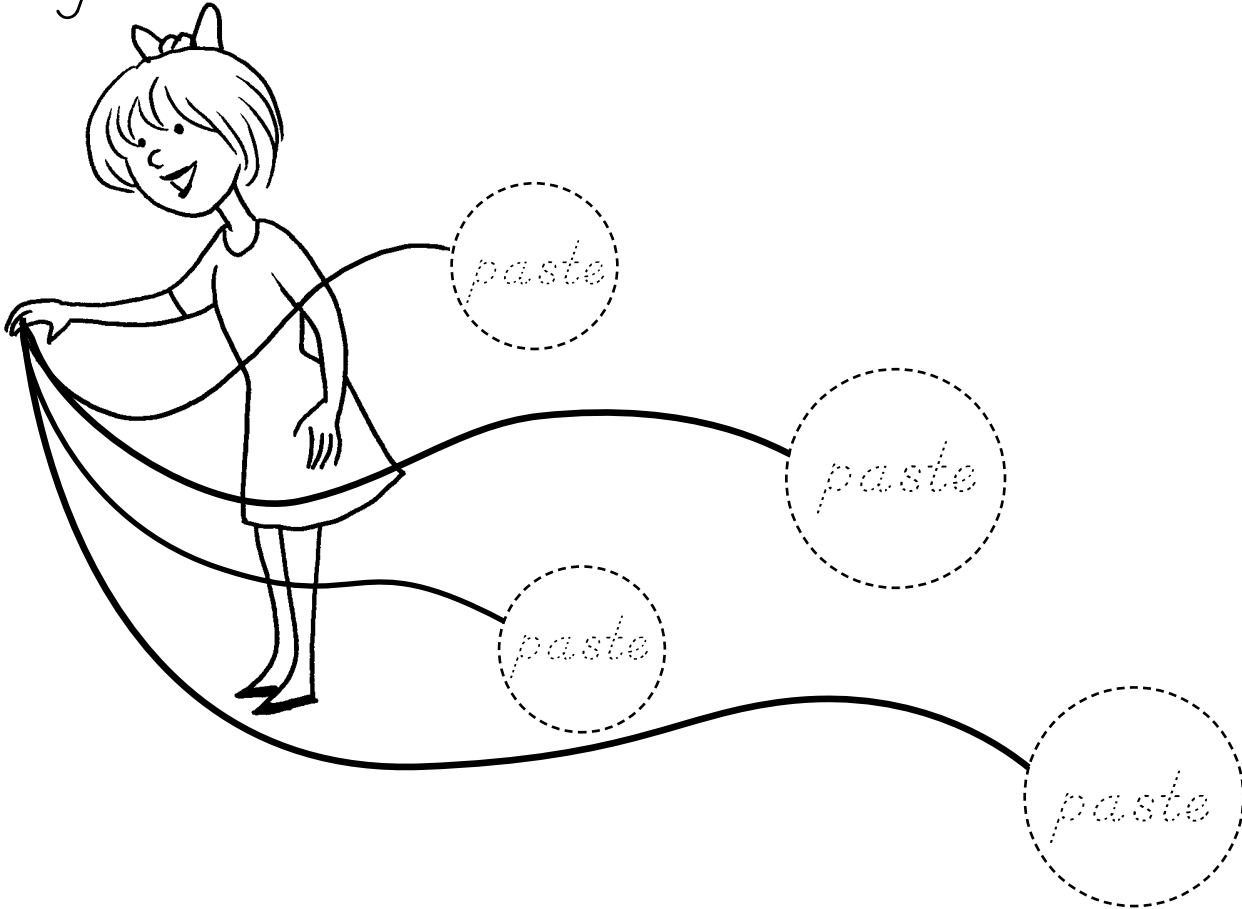

yard

yak



yarn

jump
rope

yo-yo

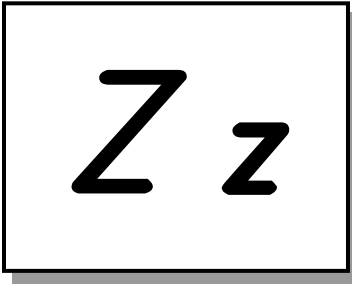
Name _____



Find a "z" picture for each  and  and  and  each picture that has the letter z.

ZOO

