

Name \_\_\_\_\_

Animals. Letter A a

Animals. Letter A a

Each animal on the farm eats food that begins with the same letter as its name. Draw a line matching the animal with its food.

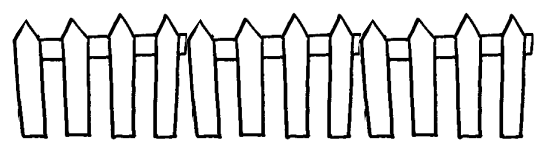
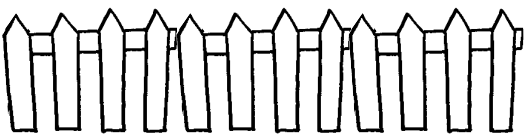
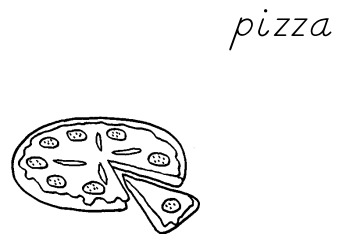
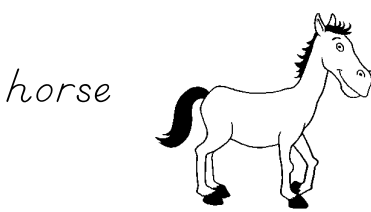
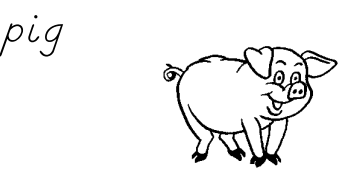
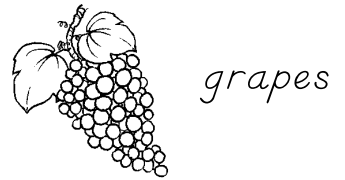
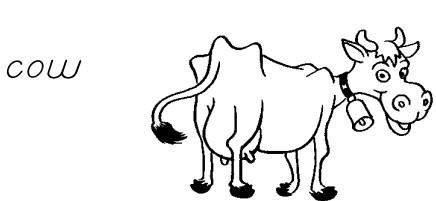

Name \_\_\_\_\_

Butterfly. Letter B b

Butterfly. Letter B b

Good job. Now find your way through the butterfly maze.

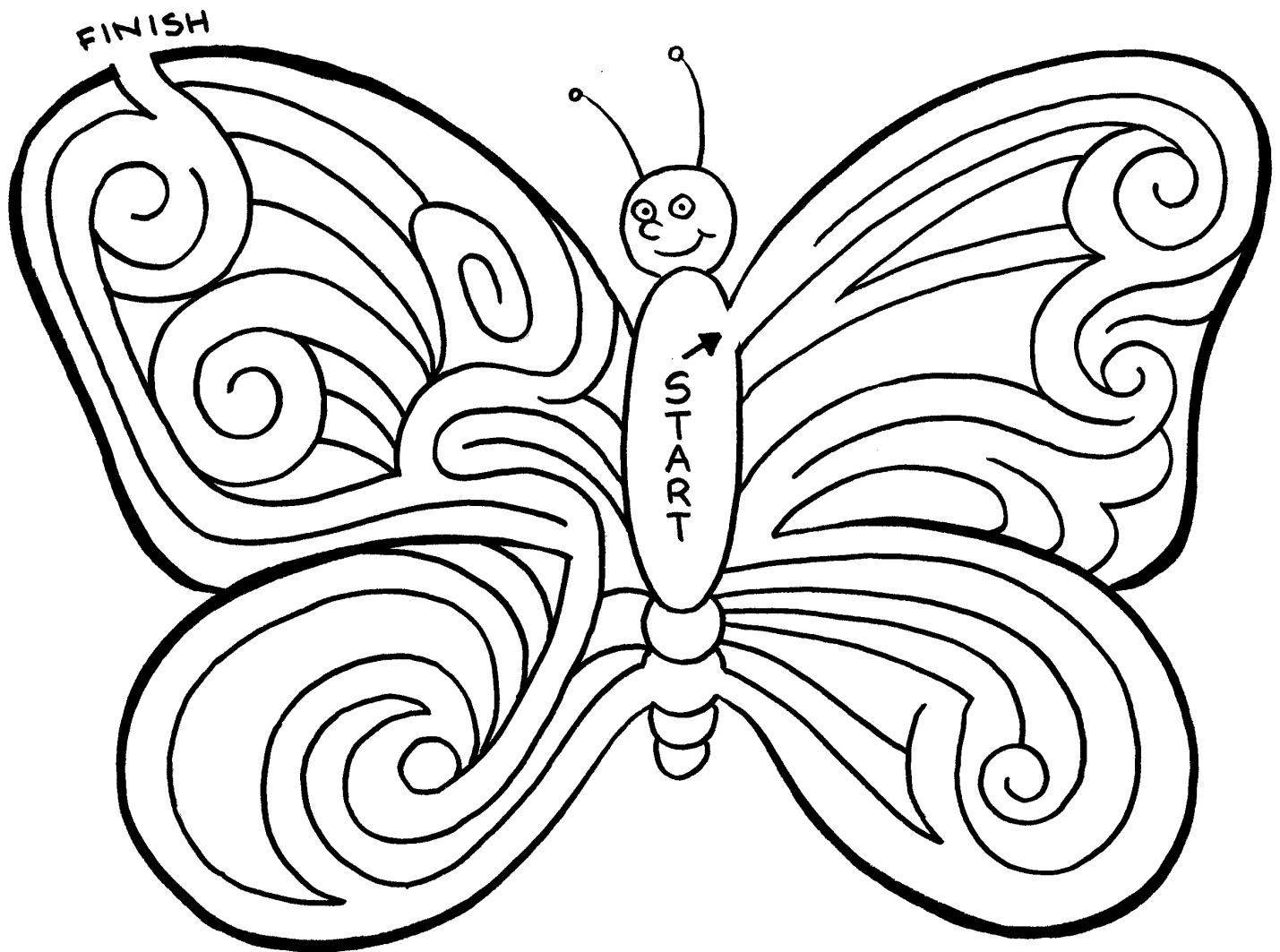

Name \_\_\_\_\_

Camel. Letter C c

Camel. Letter C c

You did it! Follow the dots in alphabetical order to find a hidden picture.

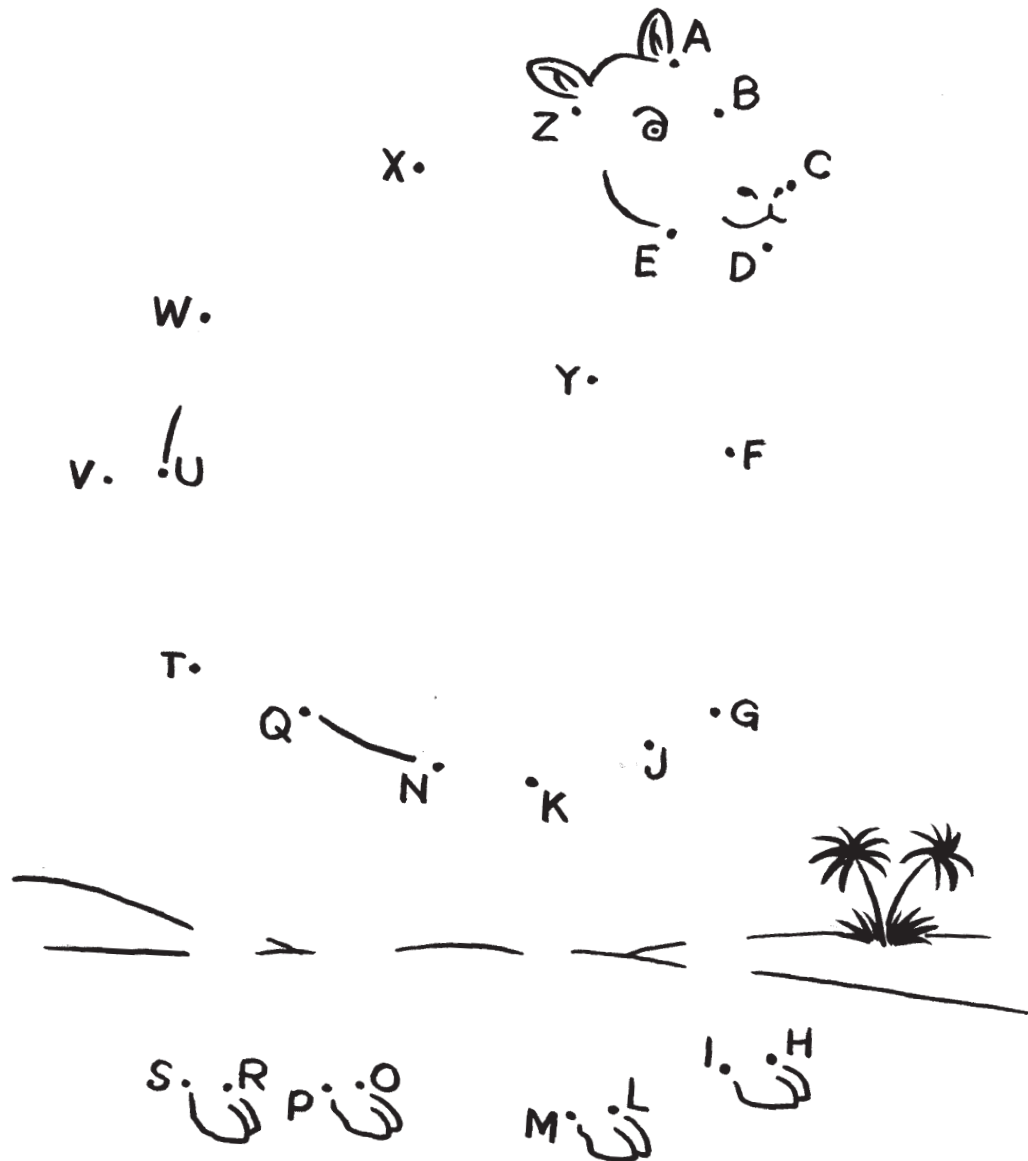

Name \_\_\_\_\_

Different letters. D d

Different letters. D d

All right. Make a new word from each word on the left by changing the first letter. Draw a line between the old and new words.



fed

train

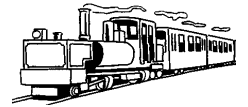

run

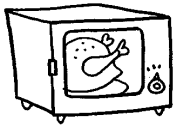

bake

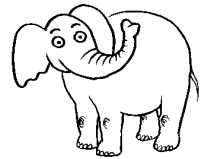

big



wig



hop



top

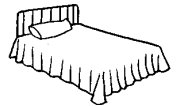

bed



brain

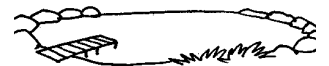

lake



hog

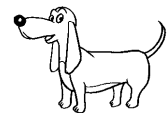

Name \_\_\_\_\_

Middle E e sound.

Middle E e sound.

Awesome! Circle the letters that make the long e sound.  
Draw a line from the word to the matching picture.

CLEAN clean



SLEEP sleep



READ read



EAT eat



ICE CREAM  
ice cream



Name \_\_\_\_\_

Fun. Letter F f

Fun. Letter F f

Brilliant. Circle the words in the puzzle that rhyme with fun.



bun



fun

c	d	s	r	u	n	m
s	u	n	p	x	o	l
p	o	b	u	n	z	s
f	b	j	n	t	l	p
u	j	k	d	u	r	u
n	t	u	x	b	a	g

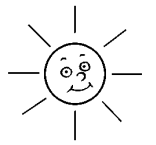

sun



run

Name \_\_\_\_\_

Words with G g  
Words with G g

Great job. Circle and color the things that begin with g.



Name \_\_\_\_\_

Words with H h

Words with H h

Terrific. Use a blue crayon to color each picture that begins with *h*.

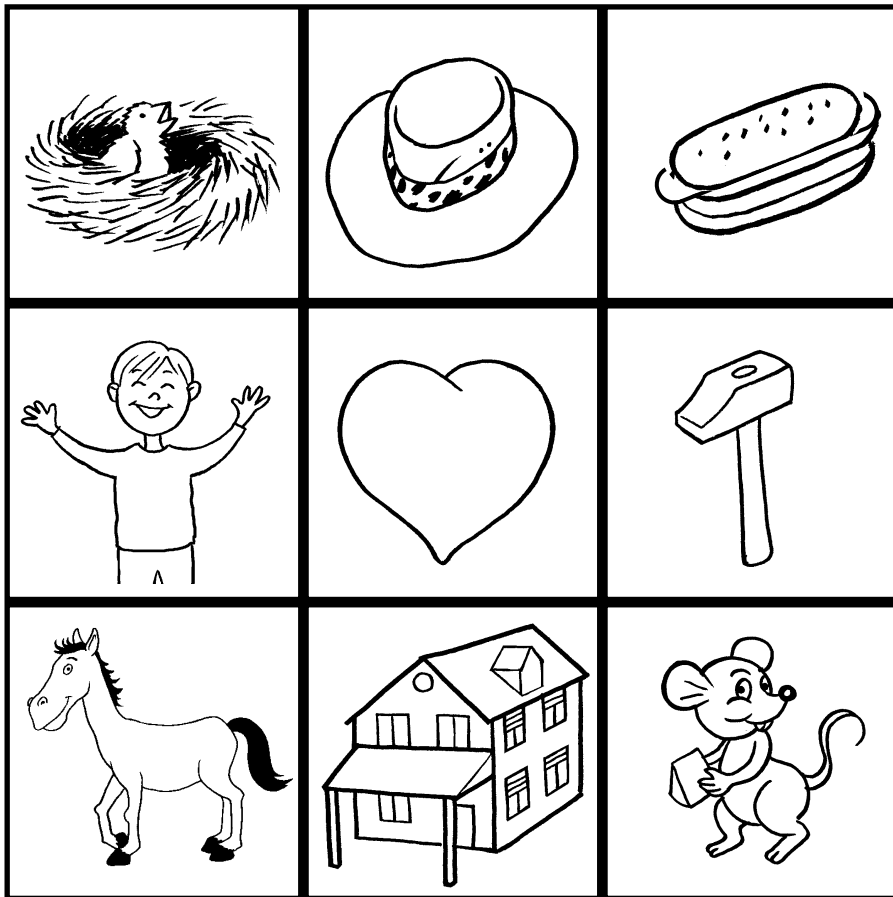

hot dog  
heart  
hammer  
horse  
happy

house  
hat  
mouse  
nest

Name \_\_\_\_\_

Words with I i

Words with I i

Great work! Look at the children in the park. Circle the pictures that have a long i sound.

- kite
- tie
- smile
- bike
- ice
- bite

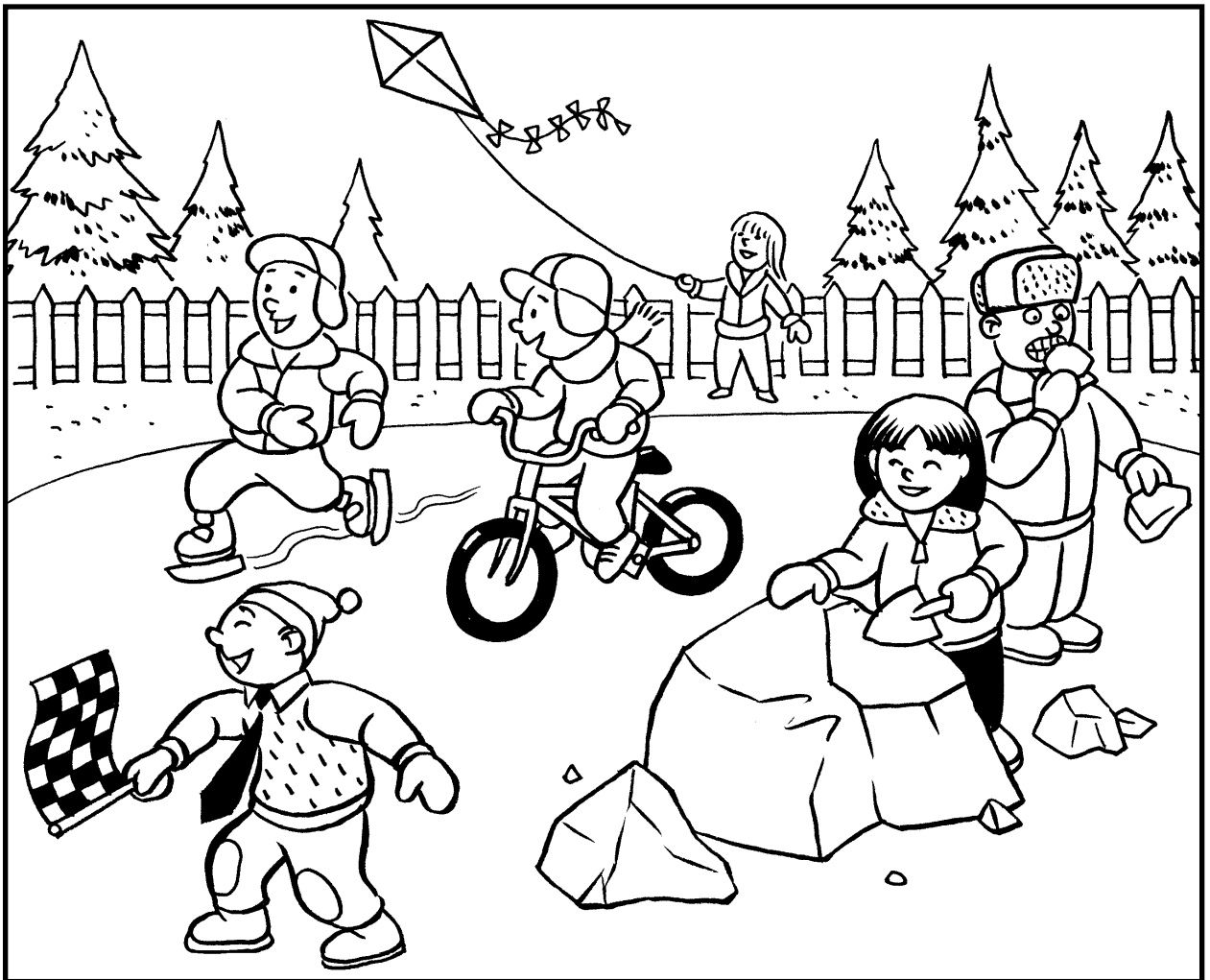

Name \_\_\_\_\_

Jet. Words with J j

Jet. Words with J j

Joyous. Fly the jet to the airport.

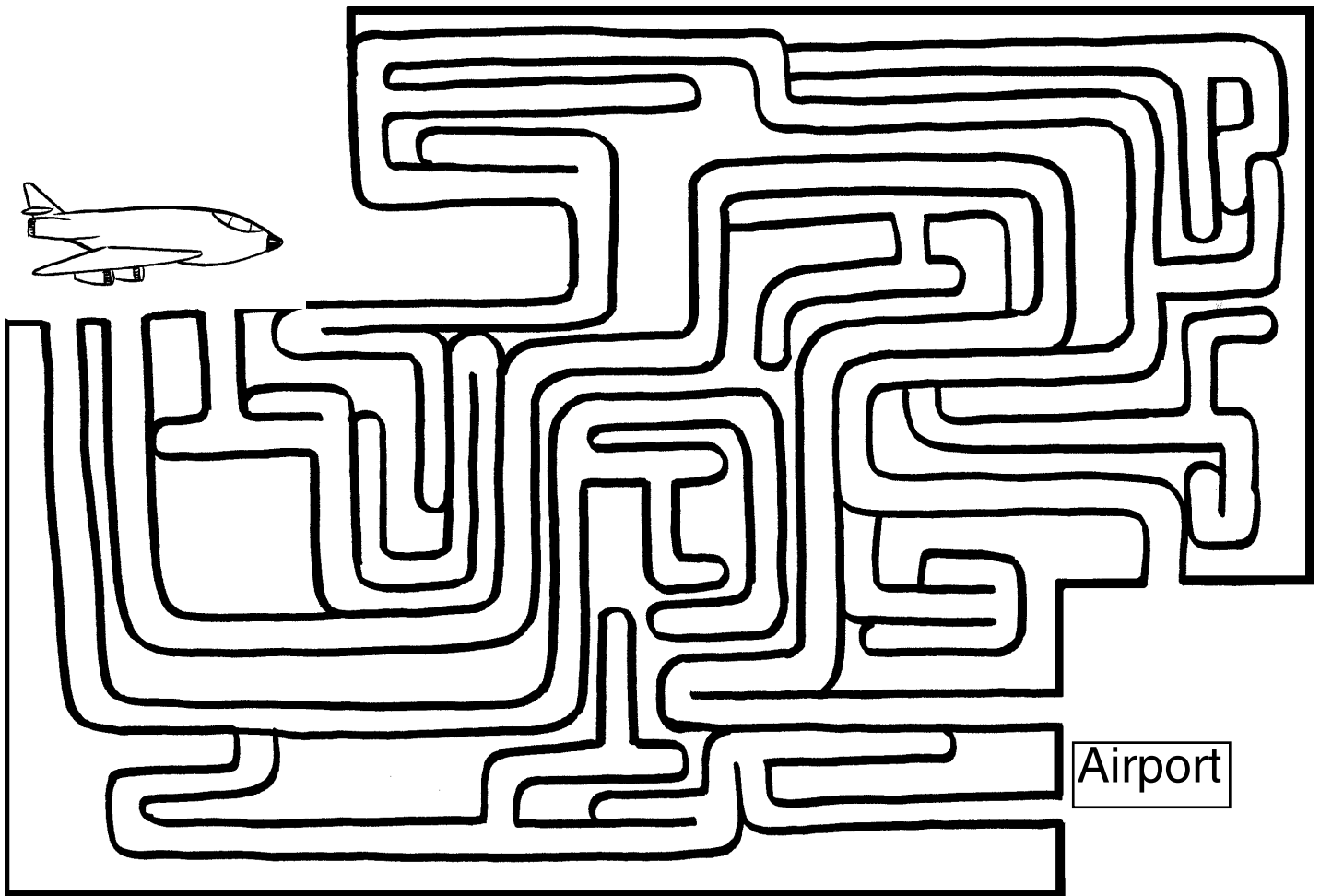

Name \_\_\_\_\_

Kangaroo.

K k

Kangaroo.

K k

Cool! Connect the dots in alphabetical order to find a hidden picture.

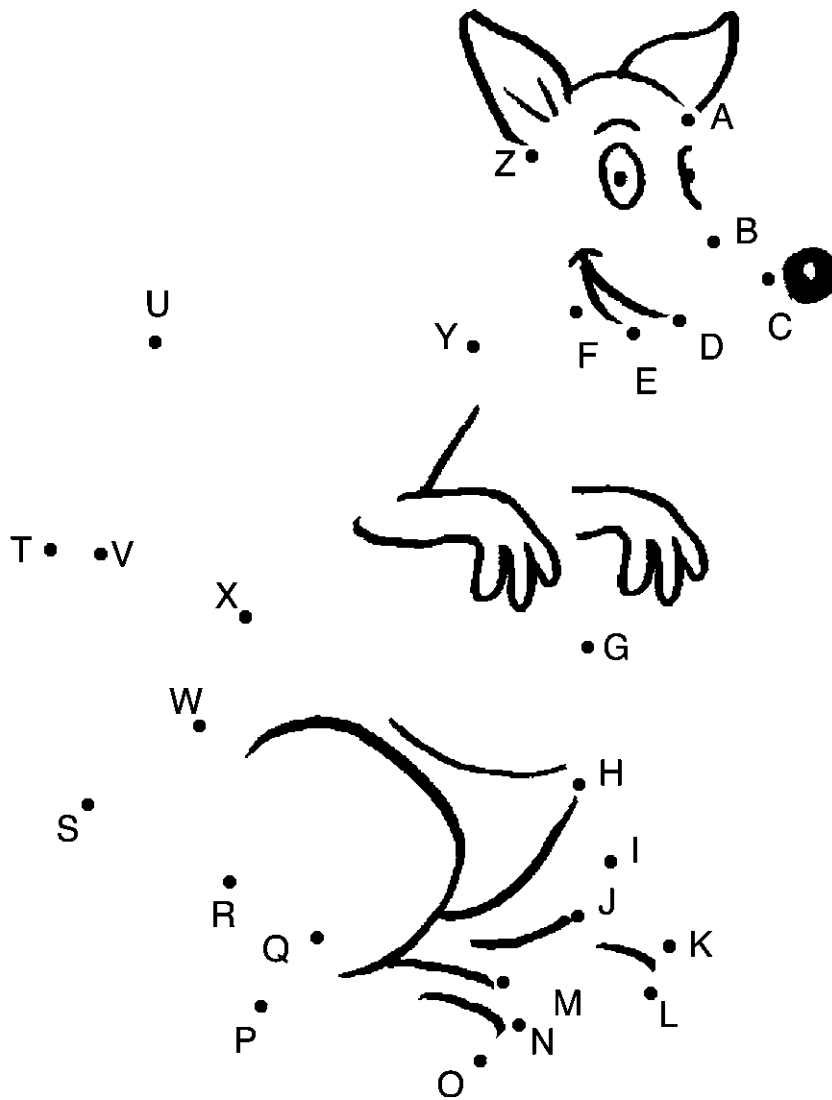

Name \_\_\_\_\_

Words with L l

Words with L l

Wonderful. Use a green crayon to color each picture beginning with l.

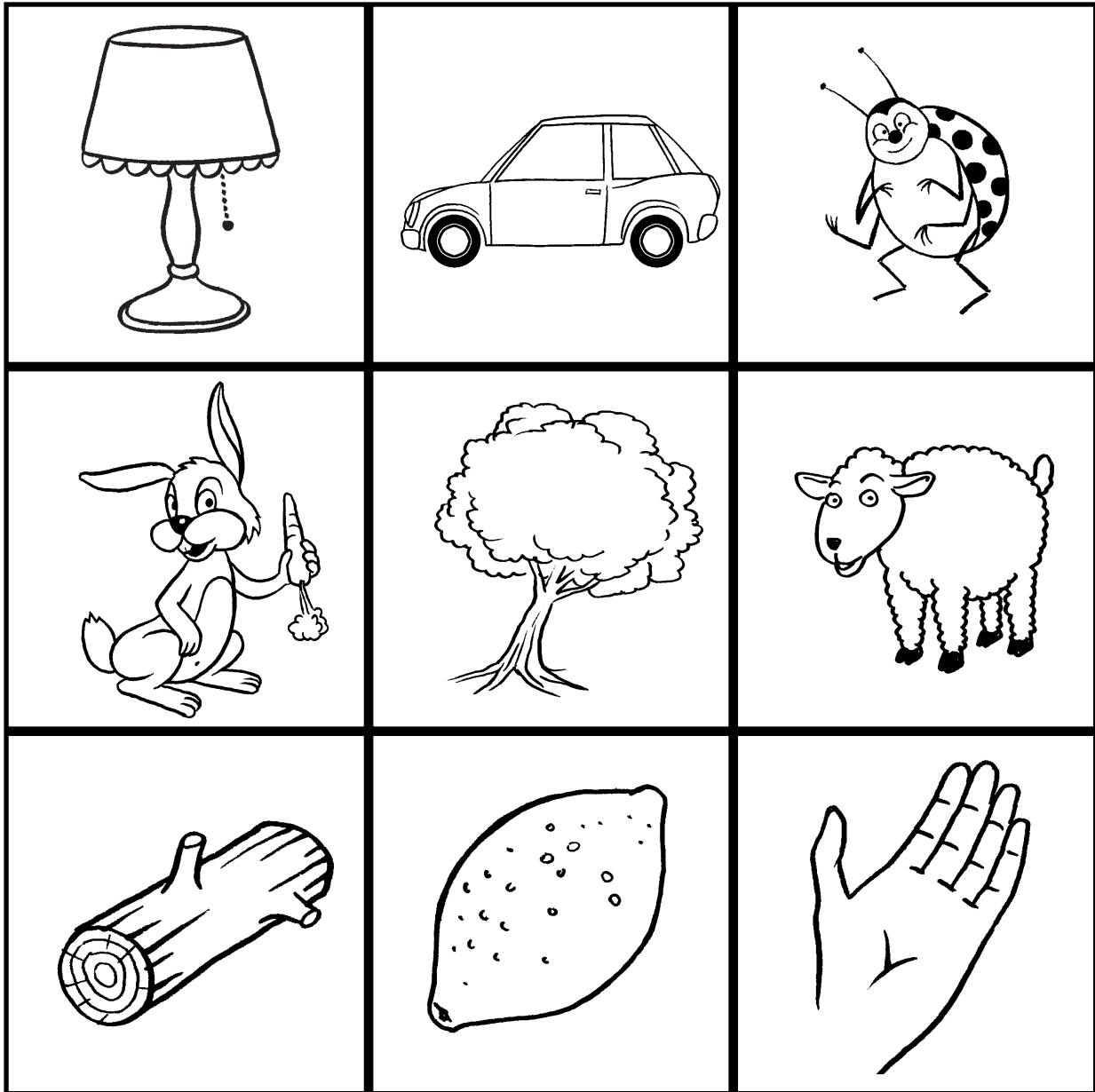

Name \_\_\_\_\_

Monster. Letter M m

Monster. Letter M m

Super. Draw the missing half of the monster.

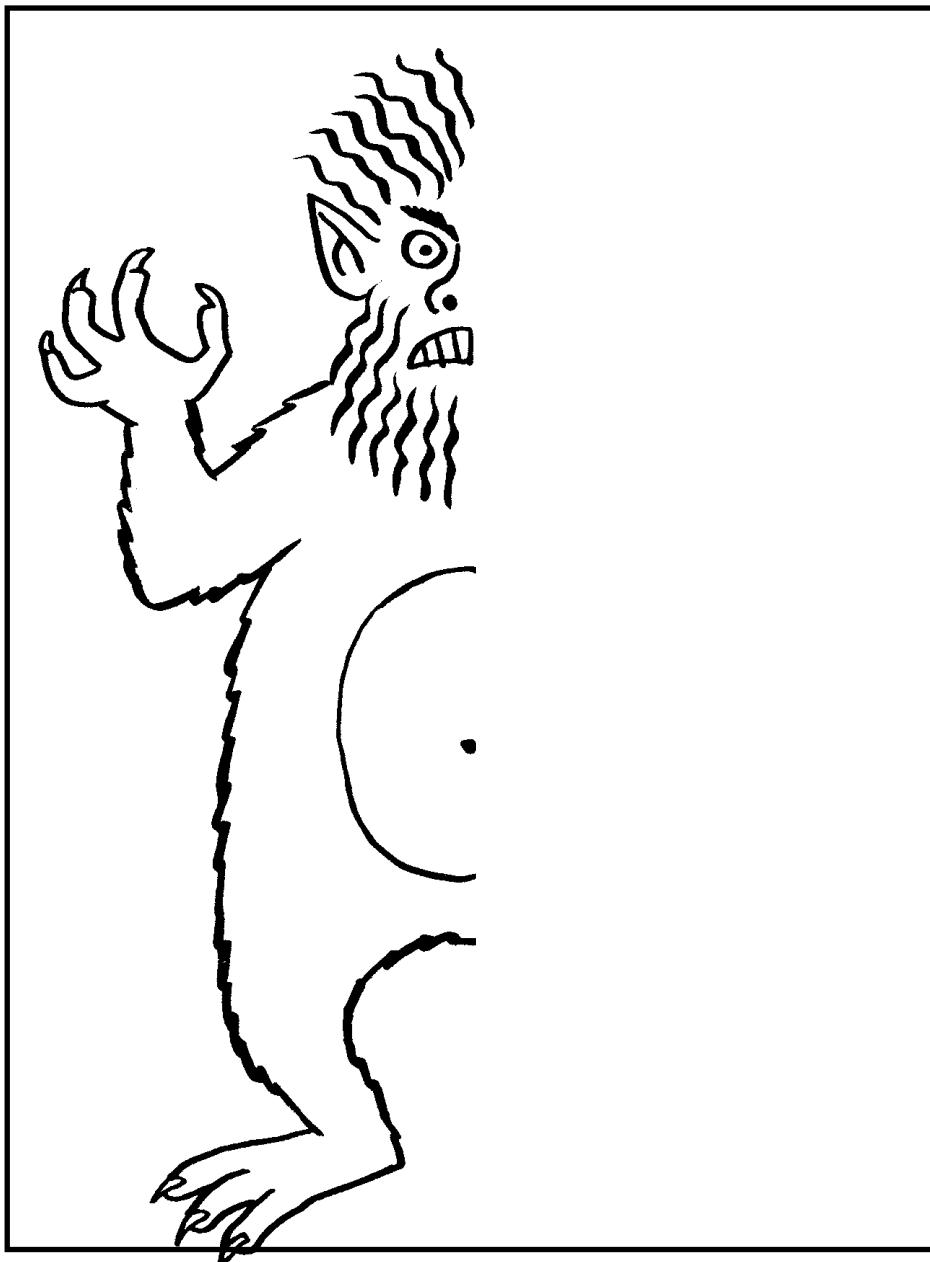

Name \_\_\_\_\_

Words with N n  
Words with N n

Good going. Find and color 7 things that begin with n.



newspaper  
needle

nine  
nest

nut  
nail

nickel

Name \_\_\_\_\_

Words with long O o

Words with long O o

Superb! In the park there are many things with the long o sound. Circle them.

rose  
nose  
hose  
bone  
home

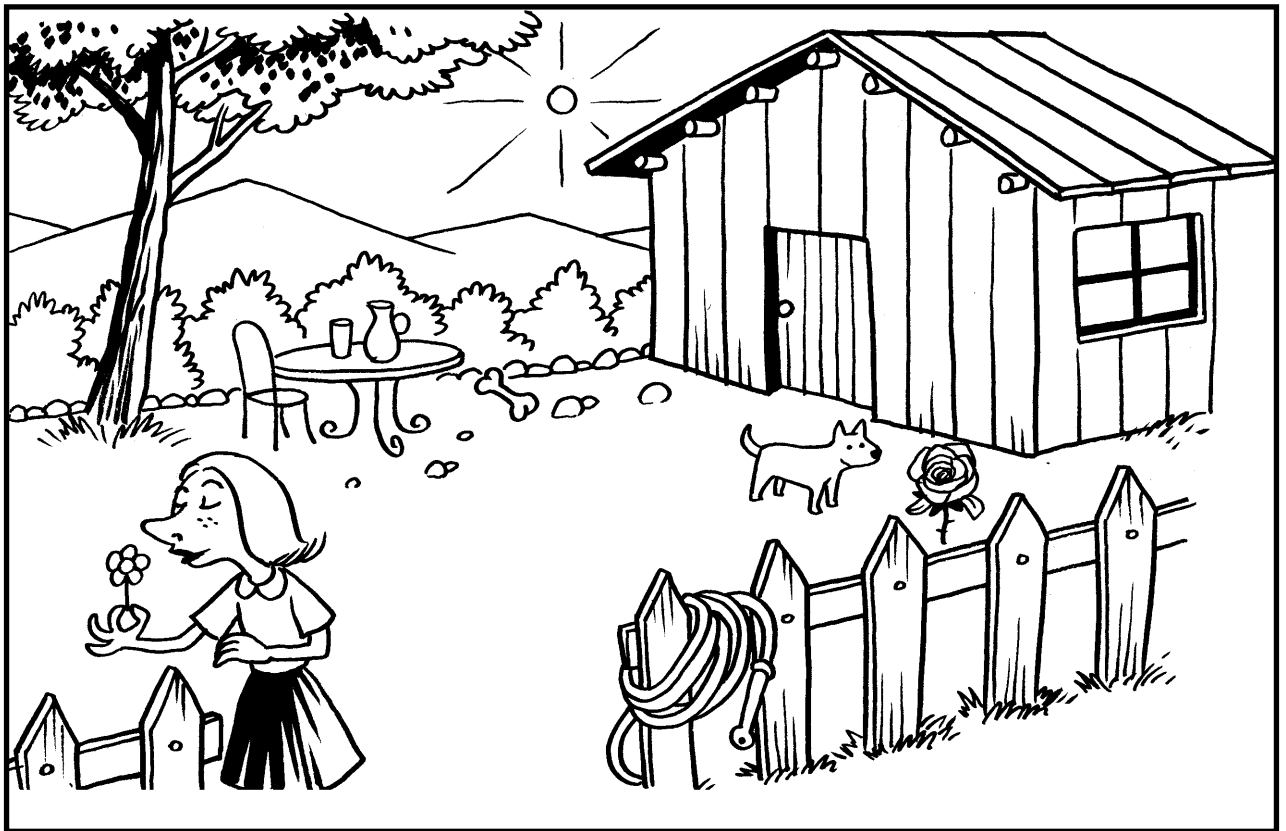

Name \_\_\_\_\_

Words with P p

Words with P p

Outstanding. Color the spaces with pictures that DO NOT begin with p.

- pig
- pear
- pail
- piano
- pot
- puppet
- umbrella
- duck
- cap
- ear
- fence

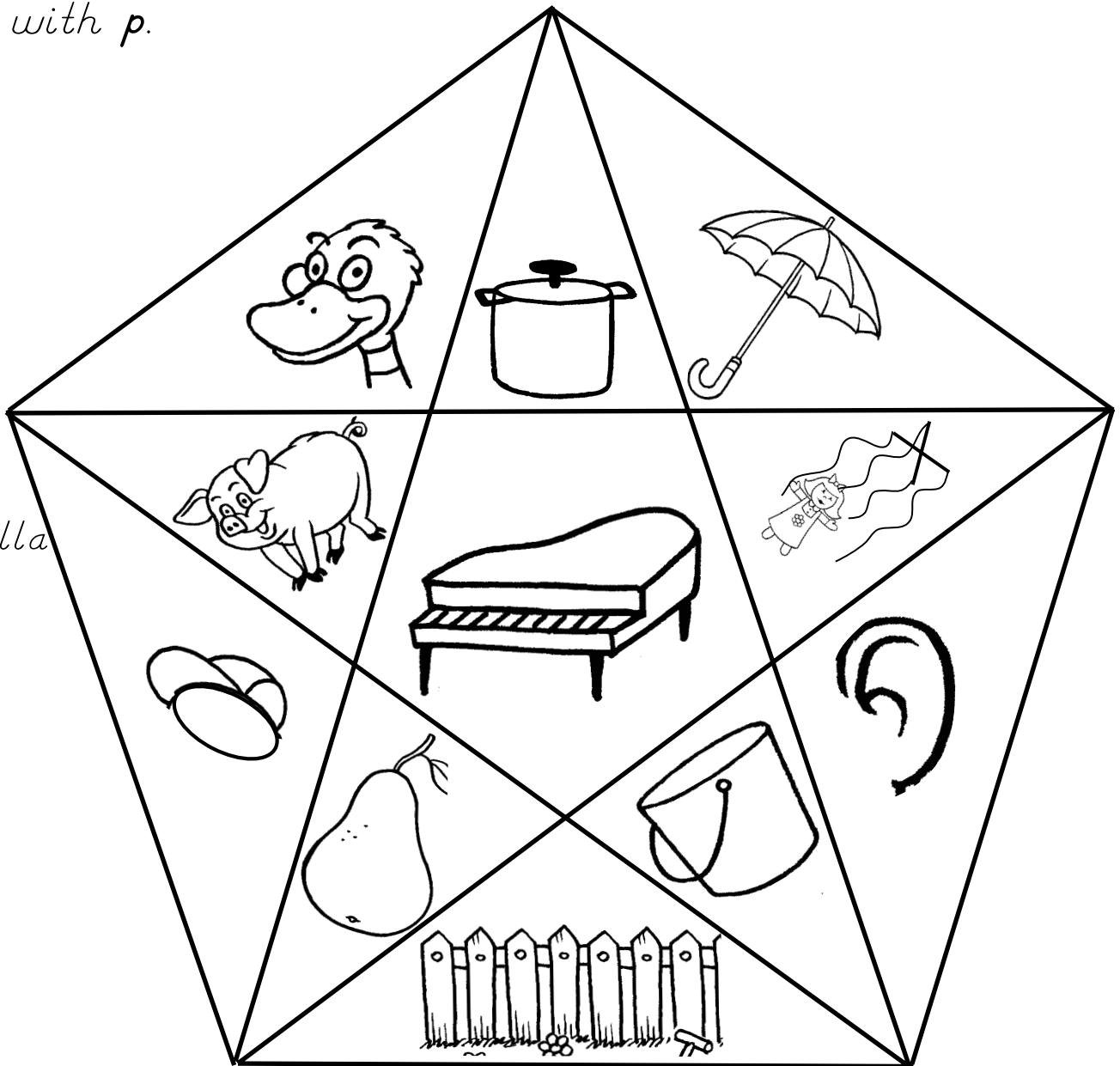

Name \_\_\_\_\_

Queen. Q q
Queen. Q q

Fine job. Help the queen find her way back to the castle.

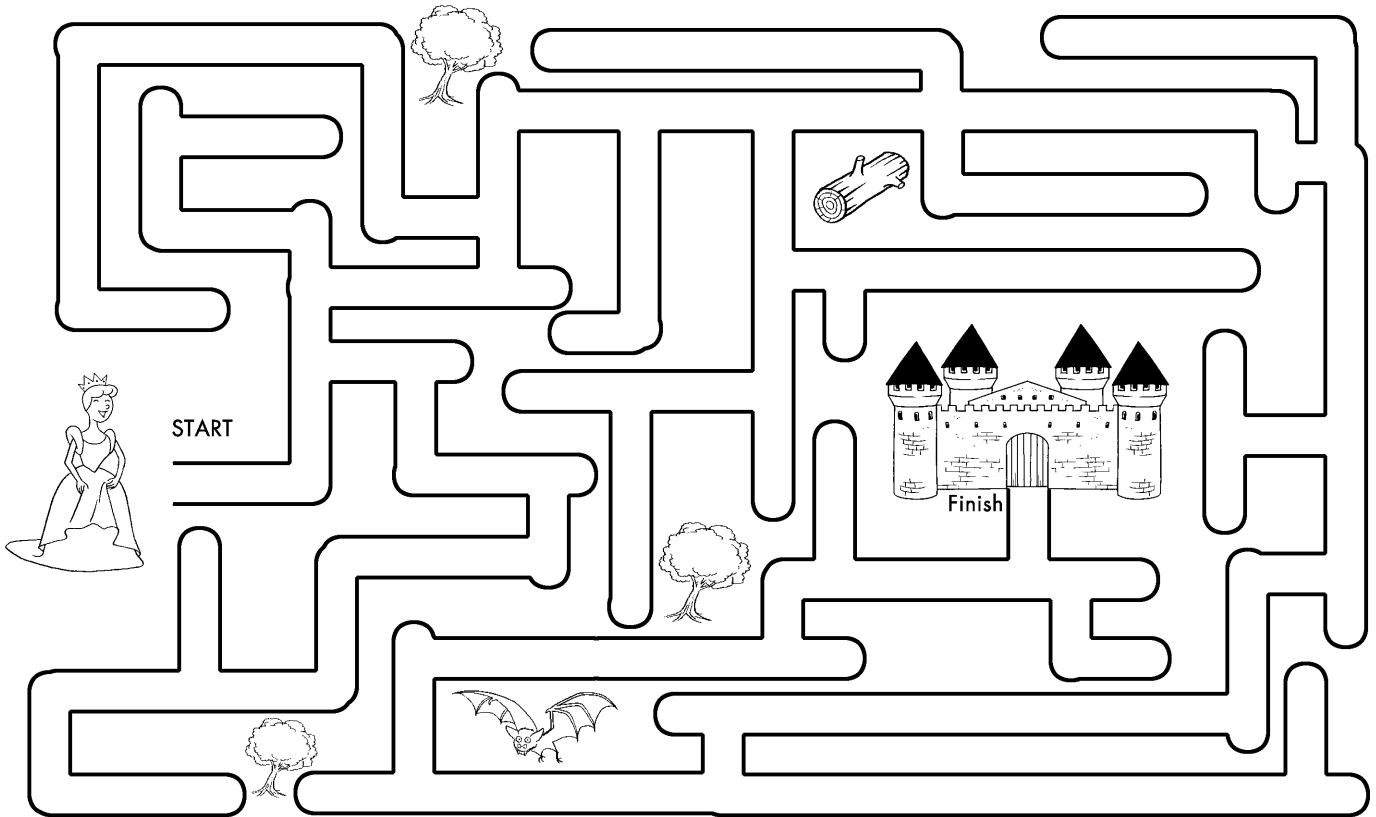

Name \_\_\_\_\_

Rabbit. Letter R r

Rabbit. Letter R r

Success. Circle the words in the rabbit.

- rabbit
- hop
- bunny
- fluffy
- hare
- tail
- jump
- long
- soft
- ears
- carrot
- quiet

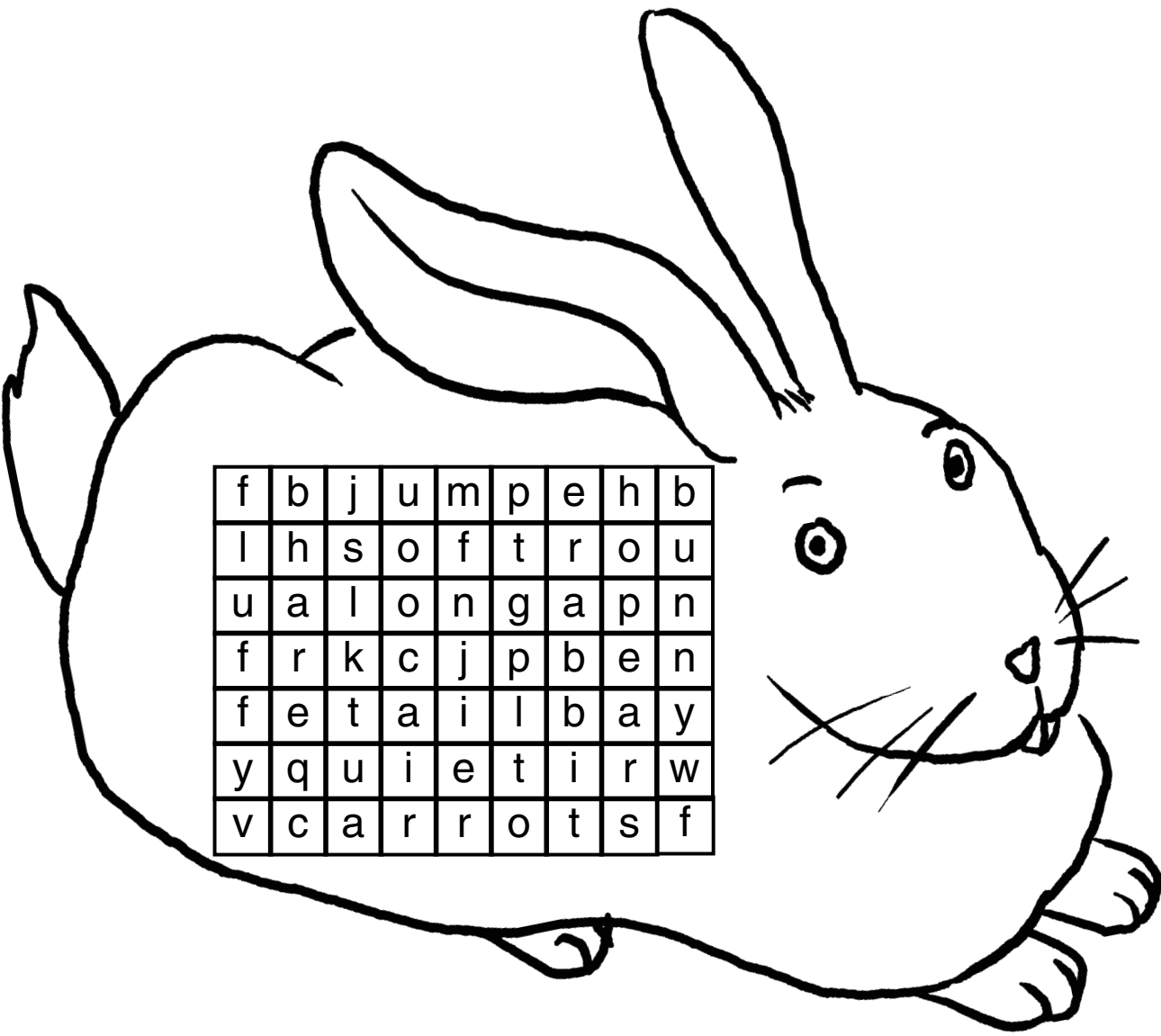

Name \_\_\_\_\_

Snail. Letter S s

Snail. Letter S s

Excellent. Help the snail find his way to the center of the maze.



Name \_\_\_\_\_

Tails. Letter T t

Tails. Letter T t

Fantastic. Help each animal find its tail. Say each animal's name and find the tail that has the last letter of the animal's name.

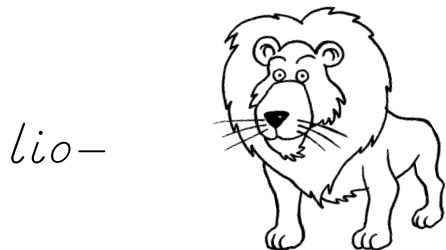
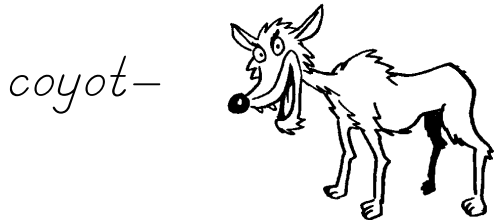
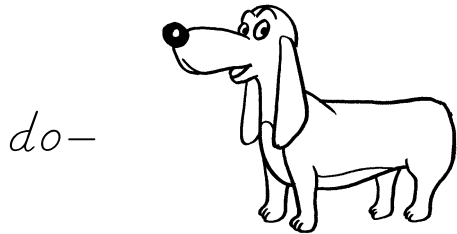
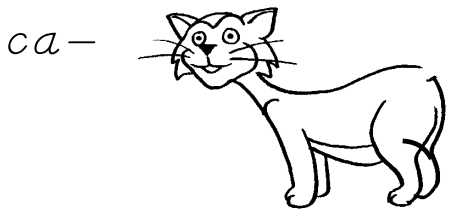

Name \_\_\_\_\_

Words with U u

Words with U u

One smart cookie. Look at the things happening at the circus. Circle all the 4 items that begin with u.

Umpire umbrella up unicorn



Name \_\_\_\_\_

Words with V v

Words with V v

Well done. Find and color 6 things that begin with v.

- veil
- vacuum
- vase
- vegetables
- van
- violin

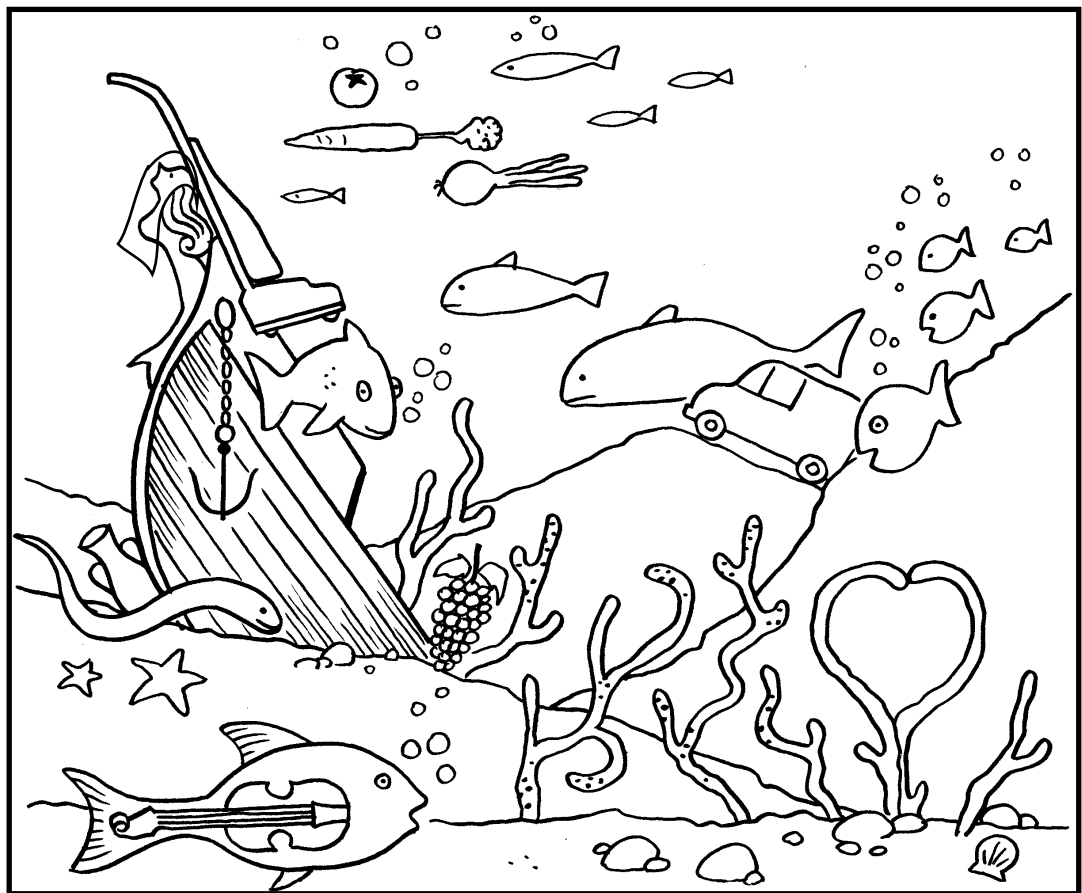

Name \_\_\_\_\_

Watermelon. W w  
Watermelon. W w

Fantastic. Color the hidden picture.

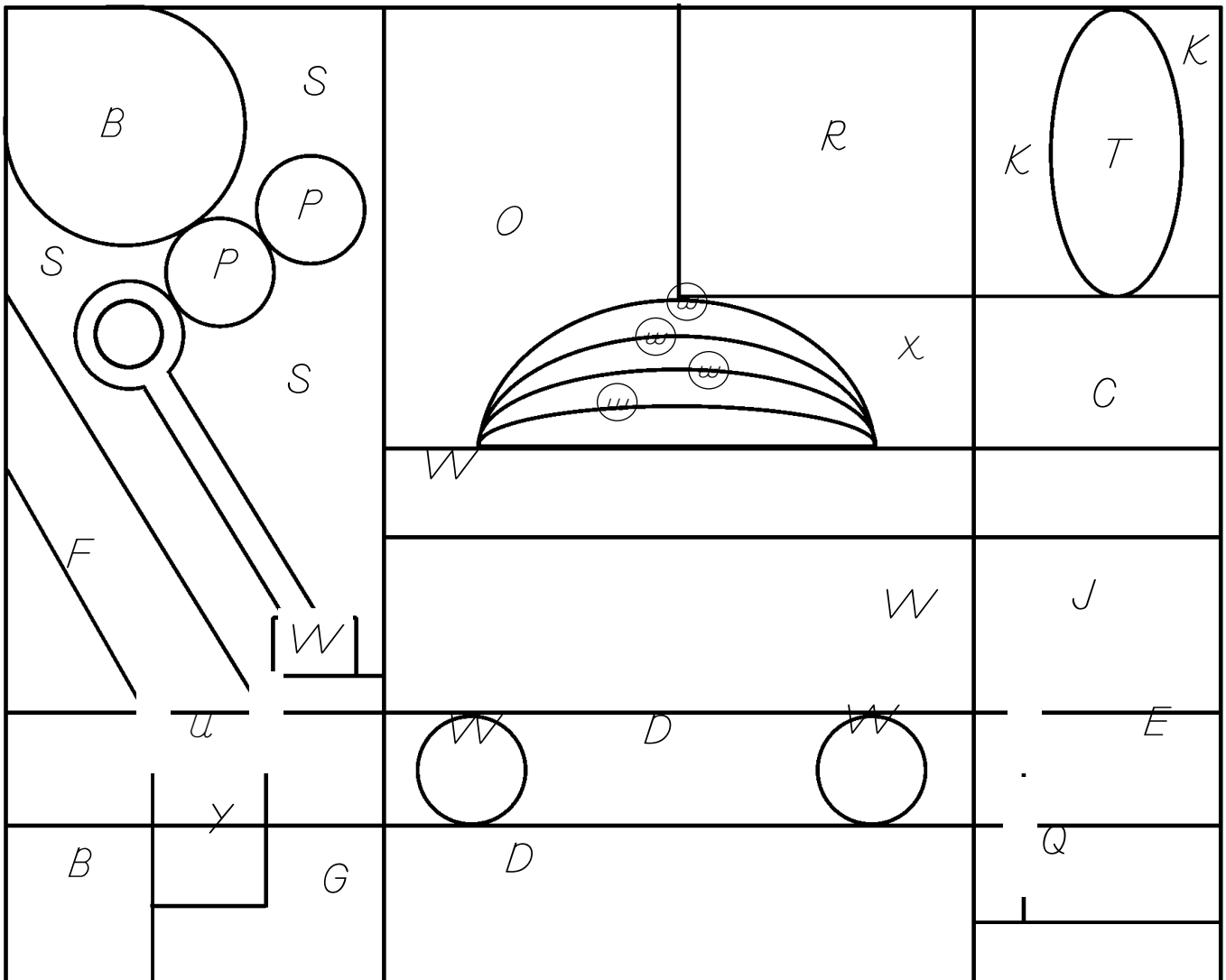
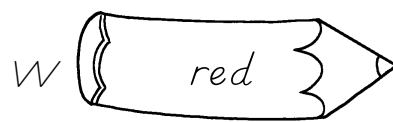
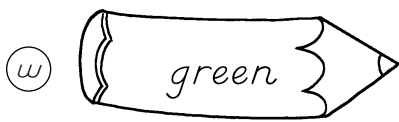

Name \_\_\_\_\_

Box. Letter X x

Box. Letter X x

Way to go! Read each word in the word box. Find a puzzle word that rhymes with it. Write the word in the puzzle.

Word Box  
tree nut bag  
jog pin head

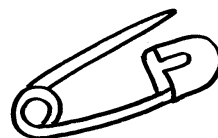
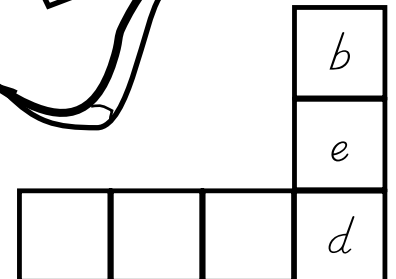
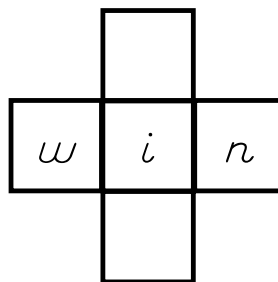
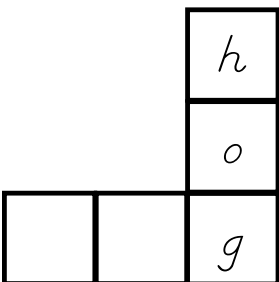
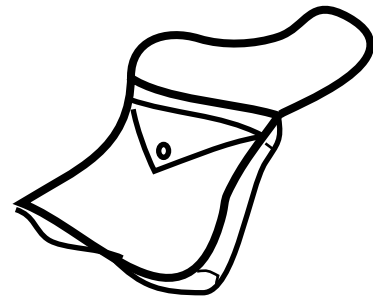
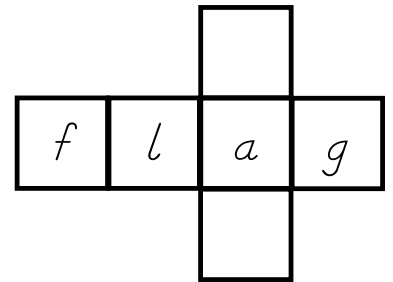
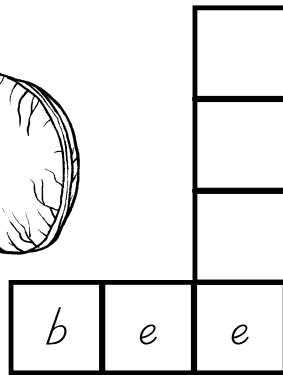
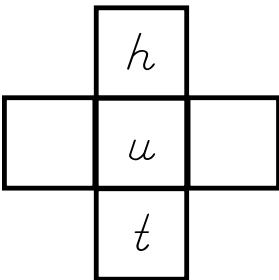

Name \_\_\_\_\_

Yard. Letter Y y

Yard. Letter Y y

You are the best. Complete the drawing of the yard.

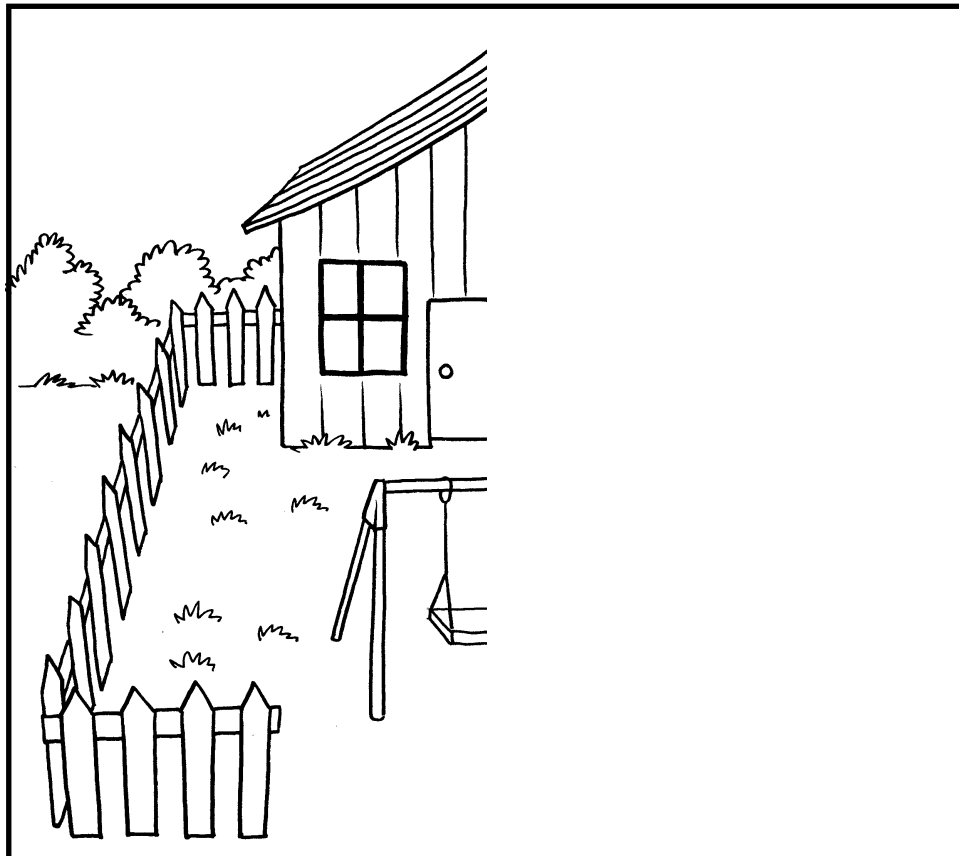

Name \_\_\_\_\_

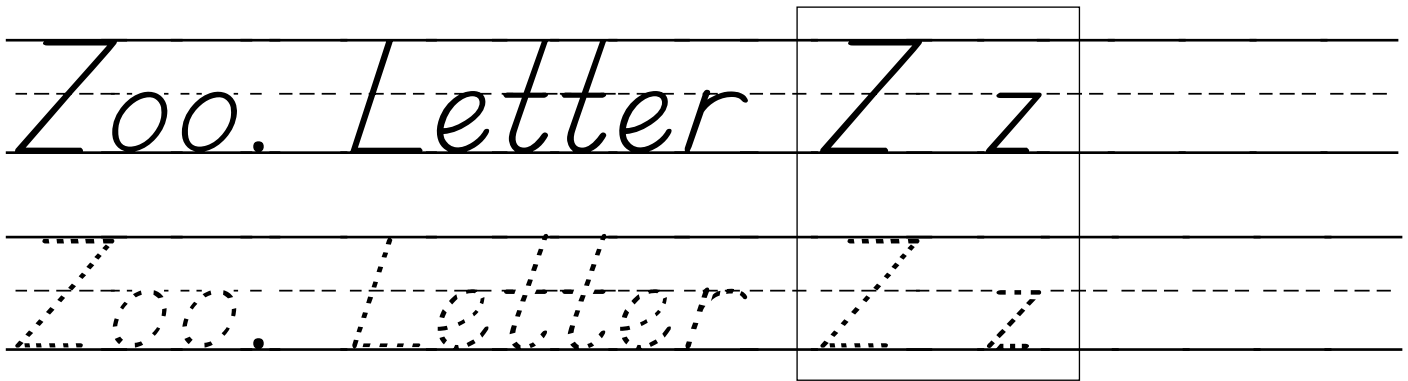

Super success! Help the bear find his way back to the zoo.

